

## WPG275\*8

### DIESEL GENERATING SET

GENERATING SET RATINGS  
50Hz – 1500rpm @ 0.8p.f.

Voltage	PRP		ESP	
	kVA	kWe	kVA	kWe
415/240	<b>250</b>	200	<b>275</b>	220
400/230	<b>250</b>	200	<b>275</b>	220
380/220	<b>250</b>	200	<b>275</b>	220

#### PRODUCT FEATURES

##### Engine

- Cast iron frame style body structure
- One-piece forged crankshaft
- Separate cast iron cylinder heads and replaceable dry cylinder liners
- Aluminum alloy pistons with oil cooling gallery

##### Cooling system

- Radiator and hoses supplied separately
- Thermostatically-controlled system with belt driven coolant pump and pusher fan

##### Fuel system

- P type fuel injection pump and injector for higher inject pressure
- Duplex fine filter and water separation filter assembly with transparent cup for better efficiency

##### Lubrication system

- Flat bottom large capacity oil pan
- Spin-on full-flow lube oil filter
- High capacity gear driven lube oil pump

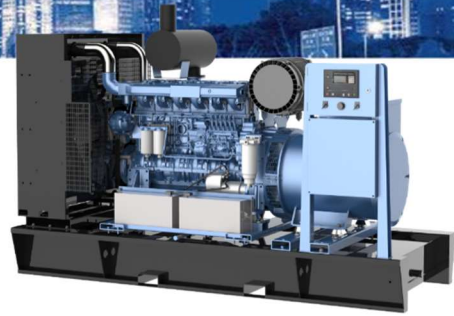

##### Electrical system

- 24 Vdc electric starter motor and battery charging alternator
- LOP + HWT sensors

##### Air intake and exhaust system

- Mid-position and below inlet turbocharger optimized for genset application
- Special rear mounted air filter with restriction indicator
- Exhaust manifold shield for heat isolating

##### Alternator

- Brushless, 4 Pole, IP23 drip-proof revolving field design
- Class H insulation and Class H temperature rise
- Low reactance with 2/3 pitch windings on the stator
- Direct-coupled by flexible disc
- Sustained overcurrent >300% in 10 sec
- Direct drive centrifugal blower fan cooling

##### Control module

- **WEICHAI** control module is ideal for a wide control range to manage, monitor, and diagnose quickly and easily.
- Display status message Provide protection Auto shutdown at fault detection



### GENERATING SET SPECIFICATIONS

Brand	WEICHAI	
Model	<b>WPG275F8</b> (Open) <b>WPG275L8</b> (Enclosure)	
Governor and regulation class	In accordance to ISO 8528-5 Class G2 performance	
Phase number and connection	3 phase, 4 wires, Y-type	
Cooling method	Closed looped water-cooled	
Starting method	DC 24V Electric starter	
Steady-state voltage deviation	≤±1%	
Steady-state frequency band	≤±1%	
Sound @7m (dB (A)) (Enclosure)	75 ± 2	

### ENGINE

Brand	WEICHAI	
Model	<b>WP10D264E200</b>	
Gross Power	kWm	ESP - 264 / PRP - 240
Cylinder / Type / Aspiration	6 / In-line / Turbocharged and Aftercooled	
Bore x Stroke	mm	126 x 130
Displacement	L	9.726
Compression ratio	17:1	
Brake Mean Effective Pressure	kPa	ESP – 2171
Governor	Electronic	

### COOLING SYSTEM

Type of Coolant	Liquid (water + 50% antifreeze)	
Total Cooling System Capacity (with Radiator)	L	35
Max coolant temperature – shutdown	°C	105
Cooling Fan Airflow	m <sup>3</sup> /min	415

### LUBRICATION SYSTEM

Operating Temperature range before Engine	°C	78 -105
Oil fuel consumption ratio based on engine fuel consumption data	g/kW.hr	≤ 0.2%
Total system capacity (including filters)	L	30
Type of oil filter	Spin-on full flow filter	

### EXHAUST SYSTEM

Exhaust Gas temperature after the turbocharger	°C	600
Exhaust Gas flow	m <sup>3</sup> /min	ESP – 50.6 / PRP – 46.8
Max. Exhaust back pressure	mBar	60
Min. diameter of exhaust pipe	mm	100



FUEL SYSTEM			
Type of fuel filter		Spin-on fuel filter	
Min. internal diameter of the supply pipe	mm	12	
Min. internal diameter of the return pipe	mm	12	
Max. fuel return restriction	Bar	0.5	
Max. fuel inlet temperature	°C	50	
Fuel supply flow	L/hr	169	
Fuel Consumption (Tolerance +3%)			
	Rating	gr/kWh	L/hr
	100%ESP	201.6	63.4
	100%PRP	199.1	56.9
	75% PRP	197	42.2
	50% PRP	198.3	28.3
	25% PRP	215.5	15.4

ALTERNATOR	
Brand	WEICHAI
Model	<b>WHA-250-4/0.4</b>
Rated Current	361A
Coupling / No. of Bearing	Direct / Single
Winding Pitch	2/3
Type of Excitation	Self-excitation
Cooling type	Air
Voltage regulation method	AVR
Insulation	Class H
Temperature rise	Class H
Protection Grade	IP23
Efficiency at 0.8p.f.@100% load	92.7%

CONTROL MODULE
The WEICHAI controller model <b>WHC 6120NC</b> is an Auto Mains Failure Control Module
Back-lit LCD display
3 Phase generator and 3 Phase Mains monitoring
Monitoring speed, frequency, voltage, current, oil pressure, coolant temperature and fuel level
Display warning, shutdown and engine status information
Hours counter provides accurate information for monitoring and maintenance.
With RS485 communication port, can achieve “three remote” functions via MODBUS protocol

## Ratings definitions

### Emergency Standby Power (ESP):

Emergency Standby Power is the maximum power available for a varying load for the duration of a main power network failure. The average load factor over 24 hours of operation should not exceed 70% of the engine's ESP power rating.

Typical operational hours of the engine are 200 hours per year, with a maximum usage of 500 hours per year. This includes an annual maximum of 25 hours per year at the ESP power rating. No overload capability is allowed. The engine is not to be used for sustained utility paralleling applications.

### Prime power (PRP):

Prime Power is the maximum power available for unlimited hours of usage in a variable load application. The average load factor should not exceed 70% of the engine's PRP power rating during any 24 hour period. An overload capability of 10% is available; however, this is limited to 1 hour within every 12 hour period.

### Open genset

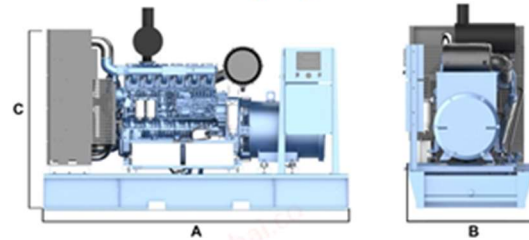

### Silence genset

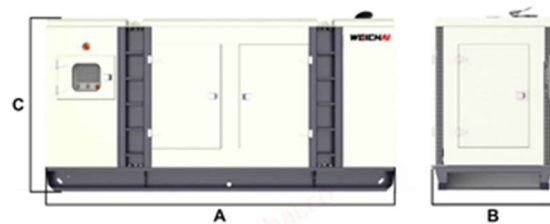

This outline drawing is to provide representative configuration details for Model series only. See respective model data sheet for specific model outline drawing number.

Do not use for installation design

## Dimension and Weight

Structure	Model	Dim "A" mm	Dim "B" mm	Dim "C" mm	Dry wt.* kg	Fuel tank L
Open	WPG275F8	2999	1170	1920	2440	420
Enclosure	WPG275L8	3900	1350	2050	3160	500

\* Note: Weights represent a set with standard features. See outline drawings for weights of other configurations.

## Codes and standards

ISO 9001	This generator set is designed and manufactured in facilities certified to ISO 9001.	ISO 8528	This generator set has been designed to comply with ISO 8528 regulation.
ISO14001	This generator set is designed and manufactured in facilities certified to environment management system ISO 14001.	CE	The CE marking is only valid when equipment is used in a fixed installation application. Material compliance declaration is available upon request.
ISO 45001	This generator set is designed and manufactured in facilities certified to OHSMS management system ISO 45001	TLC	This generator set has been certified according to YD/T502-2020 standard

Data and specifications are subject to change without notice.

For more information contact your local Weichai distributor or visit [www.weichai.com](http://www.weichai.com)

### Contact information:

#### Weichai Vietnam CO., Ltd

**Hanoi Office:** R1703, 17fl, Charm Vit Tower, 117 Tran Duy Hung, Cau Giay Dist, Hanoi

**HCM Office:** R702, Dai Minh Convention Tower, 77 Hoang Van Thai, Tan Phu Ward, Dist. 7, Ho Chi Minh City

**Hotline:** 1800 6323



## WEICHAI DIESEL ENGINE MODEL WP10D264E200



<b>Engine Model:</b>	WP10D264E200
<b>Engine Type:</b>	6 Cylinders, in Line
<b>Displacement:</b>	9.726L
<b>Advertised Power/Speed:</b>	240KW/1500rpm
<b>Standby Power/Speed</b>	264KW/1500rpm
<b>Aspiration :</b>	T-charged & Intercooled
<b>Cooling Method:</b>	Water-cooled
<b>Emission Standard:</b>	Euro II
<b>Fuel Consumption:</b>	≤200g/kW.h
<b>Packing Size(L*W*H):</b>	-
<b>Gross Weight:</b>	-
<b>Delivery Time:</b>	10-20 working days
<b>Payment Terms:</b>	T/T ,L/C

### Weichai WP10D264E200 Diesel Generator Engine

General Information of Weichai WP10D264E200 Diesel Generator Engine	
Engine Model	WP10D264E200
Engine Type	6 Cylinders, in Line
Displacement	9.726L
Bore*Stroke(mm)	126*130
Ignition Sequence	1-5-3-6-2-4
Emission Standard	Euro II
Net Weight	-
Overall Dimension(L*W*H)	-
Technical Specification of Weichai WP10D264E200 Diesel Generator Engine	
Fuel System	Direct Injection Pump

Aspiration	T-charged & Intercooled
Power Output type	Continuous
Electrical System(Starter Motor/Alternator)	12V/24V
Cooling Method	Water Cooled
Governor Type	Mechanical/Electronic Governor

Performance Data of Weichai WP10D264E200 Diesel Generator Engine

Advertised Power/Speed	240kW/1500rpm
Standby Power/Speed	264kW/1500rpm
Fuel Consumption	≤200g/kW.h
Governor Rate	≤5%
Max. Continuous Running Altitude	3000 m

# WHA-250-4/0.4

Frequency	Hz	50			60					
Rated capacity (kVA)	S	250	250	250	253	275	295	305	315	
Rated power (kW)	P	200	200	200	202	220	236	244	252	
Voltage (V)	U	380	400	415	380	416	440	460	480	
Short-circuit ratio	Kcc	0.368	0.451	0.535	0.264	0.305	0.338	0.377	0.429	
<b>Reactance</b>										
Direct axis synchronous reactance	Xd	3.534	3.189	2.963	4.283	3.857	3.669	3.502	3.349	
Direct axis transient reactance saturated	X'd	0.103	0.093	0.086	0.124	0.112	0.107	0.102	0.097	
Direct axis subtransient reactance saturated	X''d	0.099	0.089	0.083	0.12	0.108	0.103	0.098	0.094	
Quadrature axis synchronous reactance	Xq	1.591	1.436	1.334	1.929	1.737	1.652	1.577	1.508	
Quadrature axis subtransient reactance	X''q	0.16	0.144	0.134	0.193	0.174	0.166	0.158	0.151	
Negative sequence reactance saturated	X2	0.13	0.12	0.11	0.16	0.14	0.13	0.13	0.12	
Zero sequence reactance unsaturated	X0	0.041	0.037	0.034	0.049	0.045	0.042	0.04	0.039	
<b>Time constant</b>										
Open circuit time constant	T'd0	1.64	1.64	1.64	1.64	1.64	1.64	1.64	1.64	
Short-circuit transient time constant	T'd	0.048	0.048	0.048	0.048	0.048	0.048	0.048	0.048	
Subtransient time constant	T''d	0.002	0.002	0.002	0.002	0.002	0.002	0.002	0.002	
Armature time constant	Ta	0.012	0.012	0.012	0.012	0.012	0.012	0.012	0.012	
No load losses	W	2484	2606	2702	3341	3540	3683	3807	3938	
Heat dissipation at full load at Class H	W	16218	15707	15607	16611	16959	17718	17989	18430	
<b>Efficiency</b>										
PF=0.8 Efficiency of 25% load	%	91.43	91.29	90.90	90.61	90.77	90.90	90.69	90.76	
50% load	%	93.51	93.56	93.42	93.22	93.44	93.52	93.46	93.52	
75% load	%	93.49	93.66	93.62	93.39	93.65	93.82	93.82	93.86	
100% load	%	92.50	92.72	92.76	92.40	92.84	93.02	93.13	93.19	
110% load	%	91.91	92.18	92.29	91.86	92.35	92.54	92.70	92.72	
PF=1 Efficiency of 25% load	%	92.24	92.08	91.78	91.33	91.50	91.51	91.48	91.44	
50% load	%	94.89	94.88	94.74	94.34	94.53	94.59	94.62	94.62	
75% load	%	95.28	95.37	95.37	94.92	95.16	95.24	95.33	95.36	
100% load	%	94.80	94.97	95.04	94.50	94.81	94.96	95.07	95.14	
110% load	%	94.48	94.69	94.22	94.21	94.53	94.73	94.83	94.90	
No load excitation current	io(A)	1.2	1.2	1.2	1.2	1.2	1.2	1.2	1.2	
Full load excitation current	ic(A)	4.4	4.4	4.4	4.4	4.4	4.4	4.4	4.4	
Full load excitation voltage	uc(V)	52	52	52	52	52	52	52	52	
Recovery time	Tr	1 s								
Waveform : TIF		<50								
Waveform : THD		No load <3% Non-Distorting Balanced Linear Load <5%								
Waveform : THF		<2%								
Winding pitch		2/3								
Steady state voltage regulation		+/- 1%								
A.V.R. model		EVC600								
Duty		Continuous								
Number of poles		4								
Class of insulation		H								
Altitude		≤1000m								
Rated power factor		0.8								
Excitation		Brushless								
Stator winding		6ends								
Rotor		With damping cage								
Overload	%	110% rated load for 1 hour								
Stator winding resistance (20°C)	ohm	0.01418								
Rotor winding resistance (20°C)	ohm	0.7569								
Exciter Stator resistance (20°C)	ohm	9.6								
Exciter Rotor resistance (20°C)	ohm	0.0508								
Cooling air requirement	m3/min	38.7			46.4					
Method of cooling		IC 01								
Ambient temperature		40°C								
Sense of rotation		Clockwise-DE								
Type of construction		1 Bearing or 2 Bearings								
Degree of protection / enclosure		IP21 or IP23								
Maximum overspeed		2250 rpm 2minutes								

## THREE-PHASE SYNCHRONOUS GENERATOR

### THREE PHASE EFFICIENCY CURVES

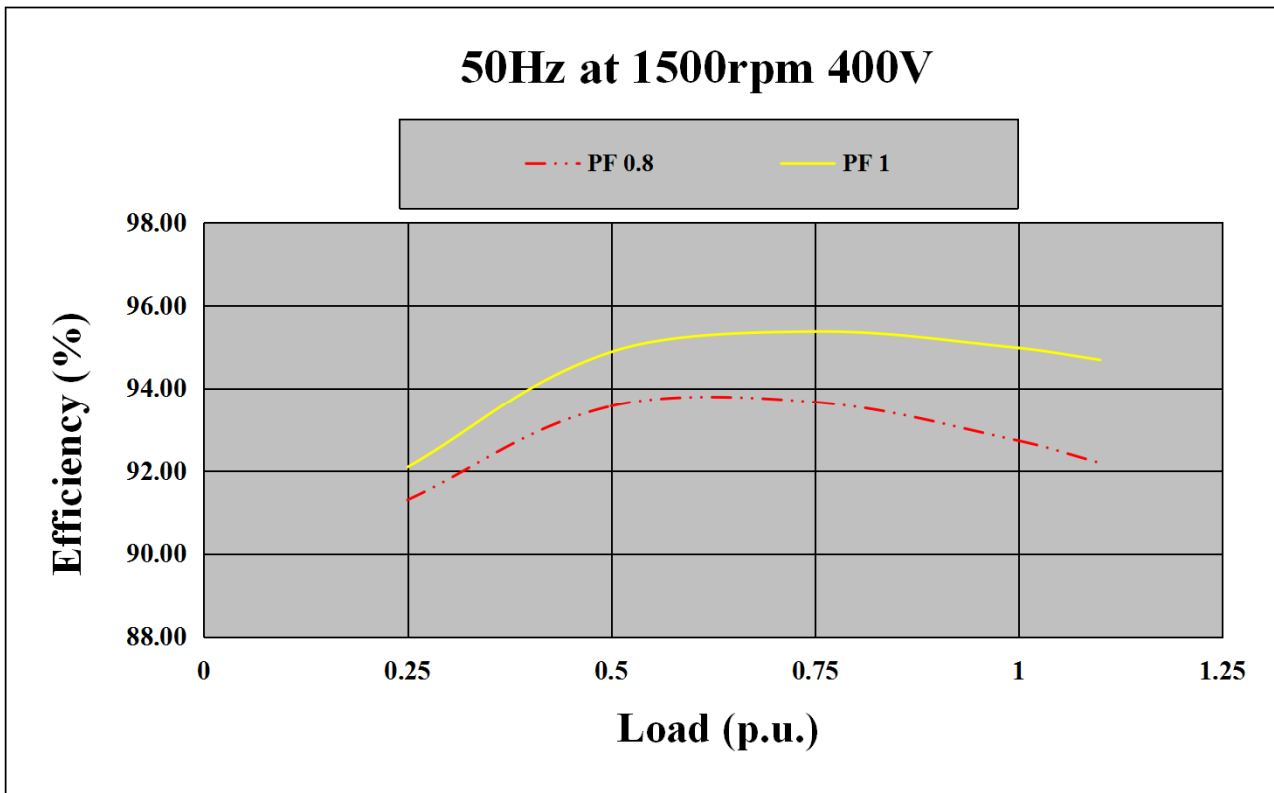
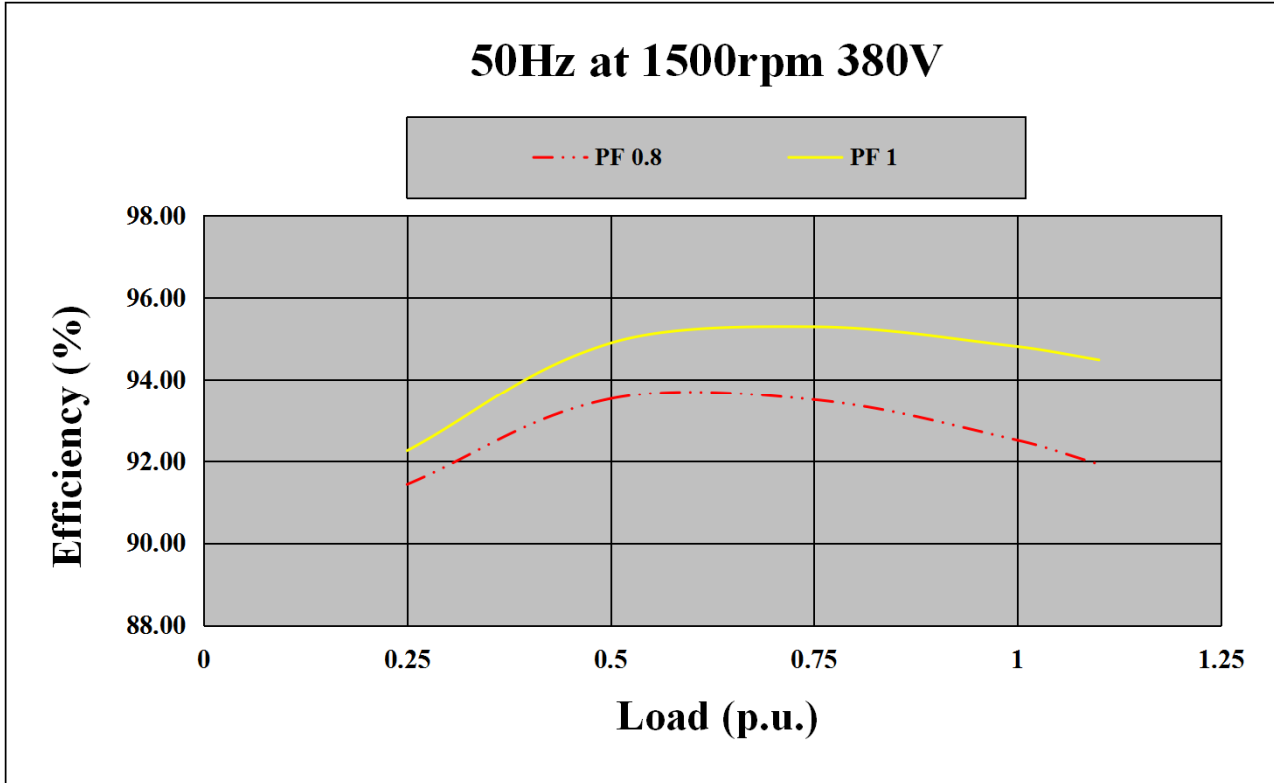



## THREE-PHASE SYNCHRONOUS GENERATOR

### THREE PHASE EFFICIENCY CURVES

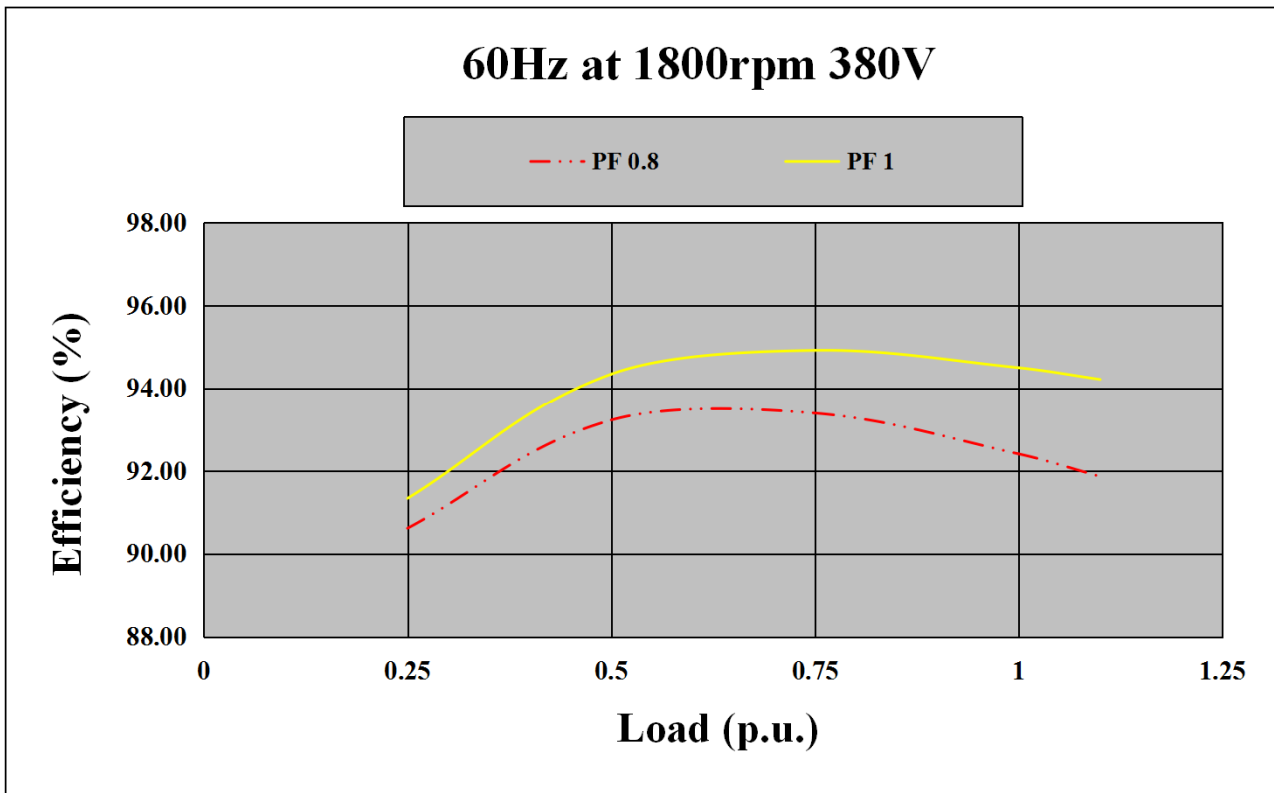
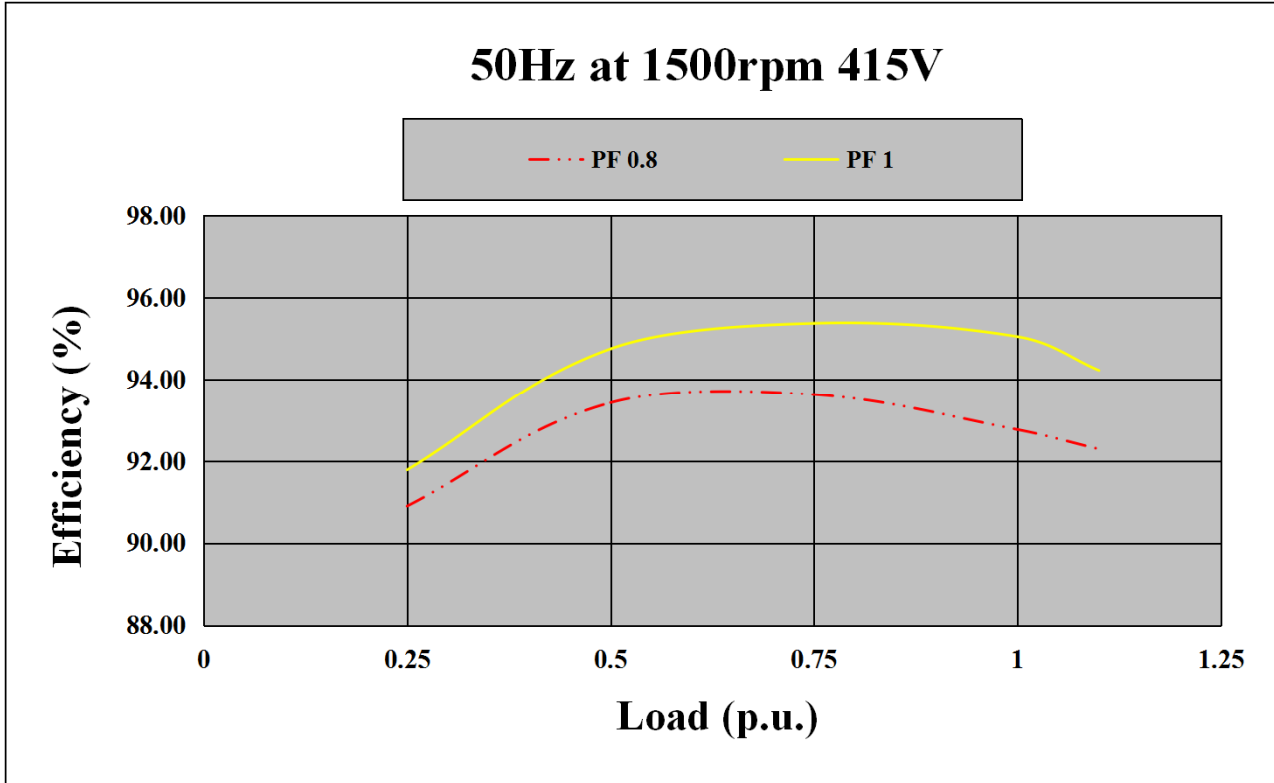

## THREE-PHASE SYNCHRONOUS GENERATOR

### THREE PHASE EFFICIENCY CURVES

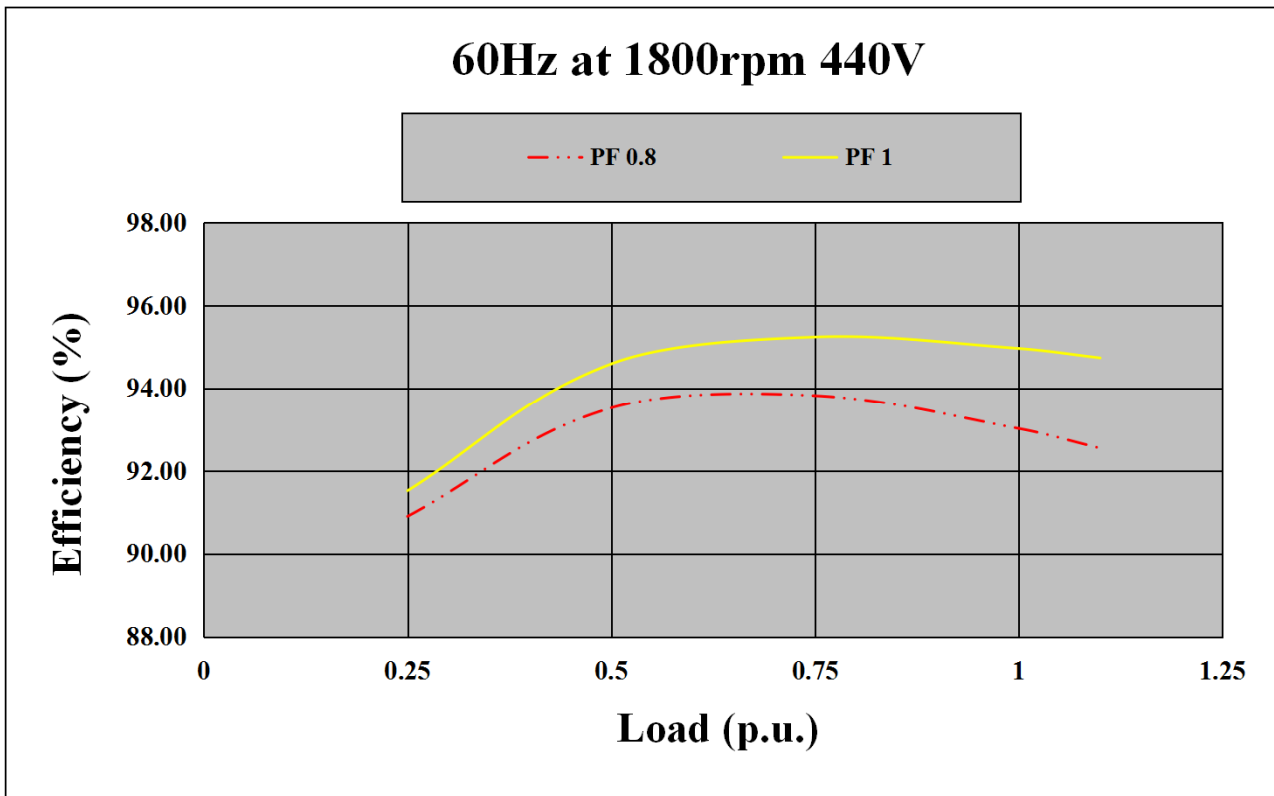
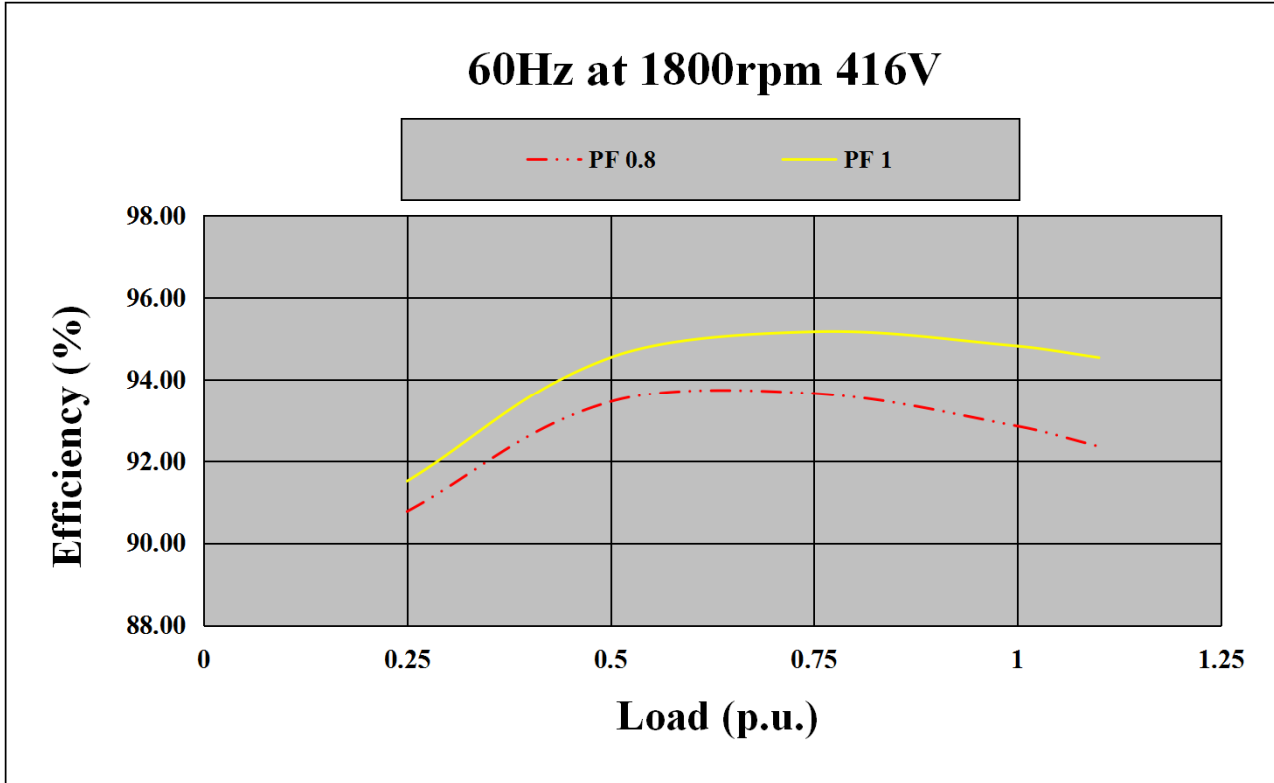

## THREE-PHASE SYNCHRONOUS GENERATOR

### THREE PHASE EFFICIENCY CURVES

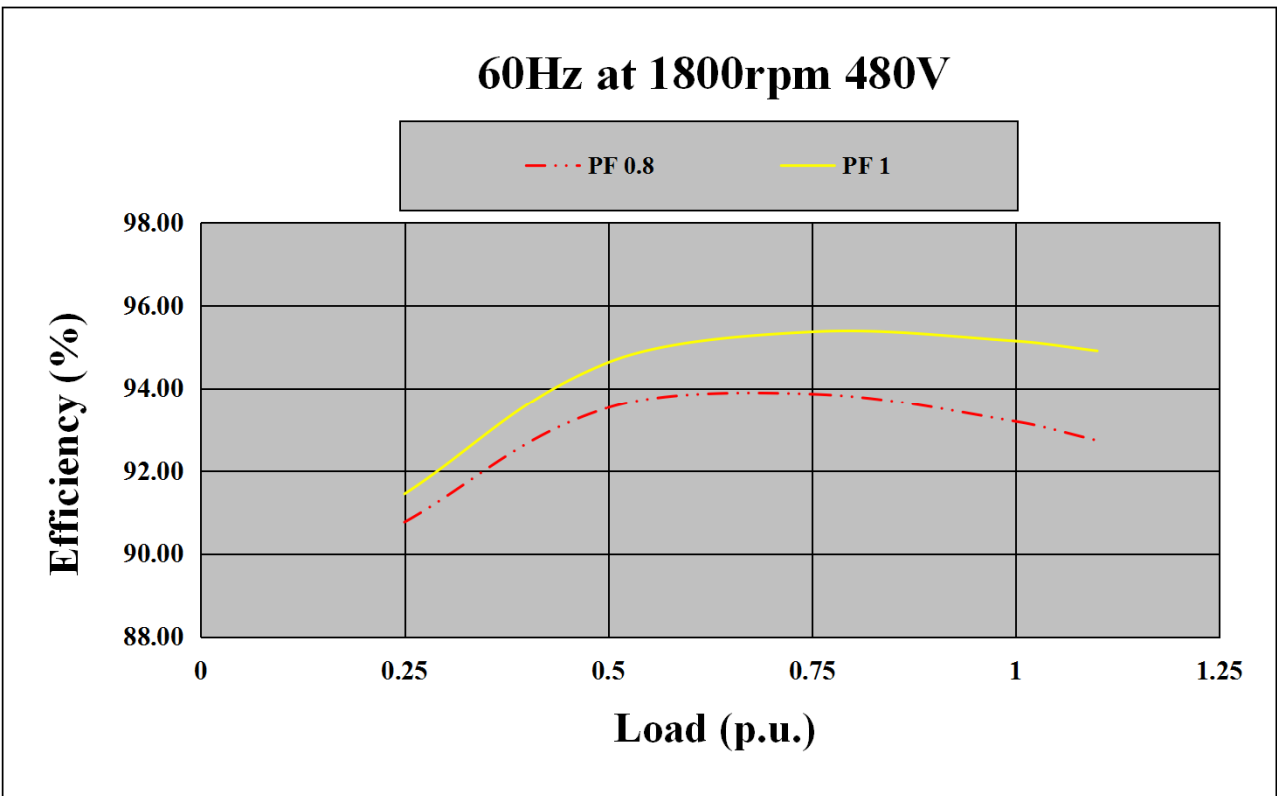
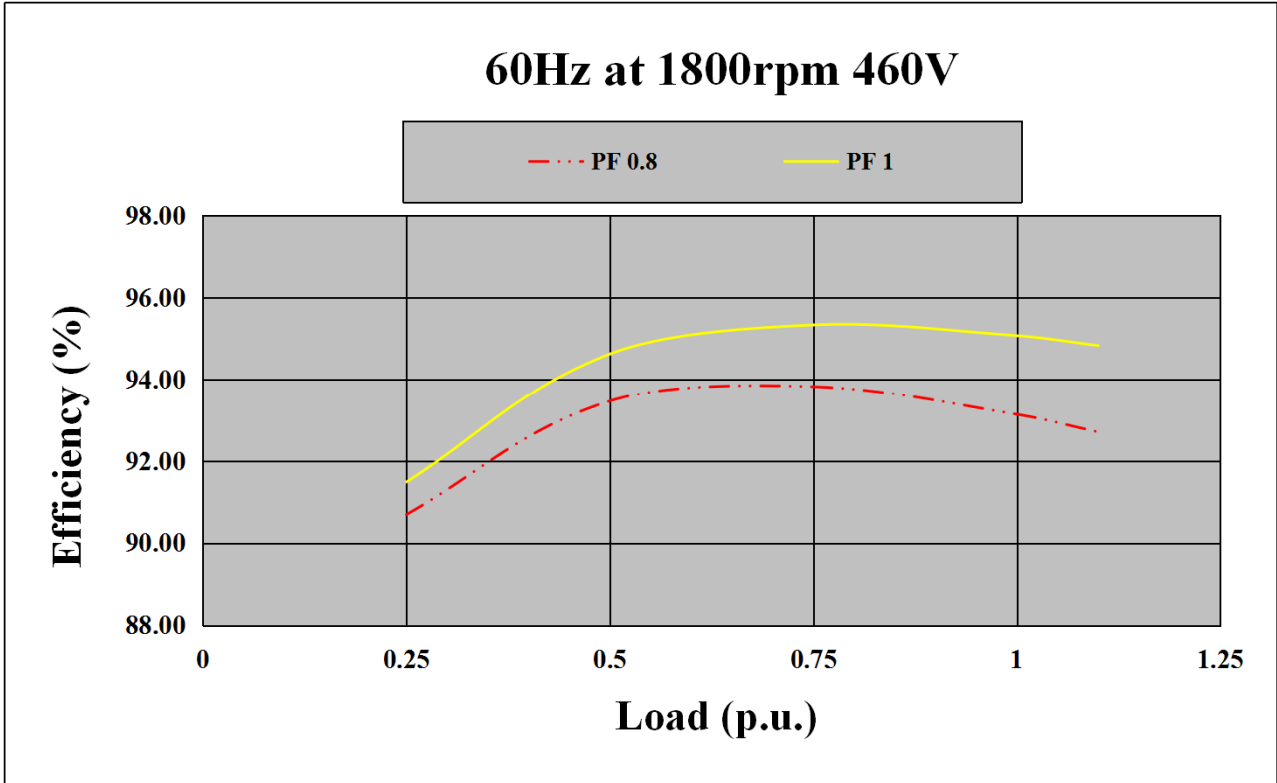

## THREE PHASE SYNCHRONOUS GENERATOR

### WHA-250-4/0.4

#### MOTOR STARTING CURVES (50Hz)

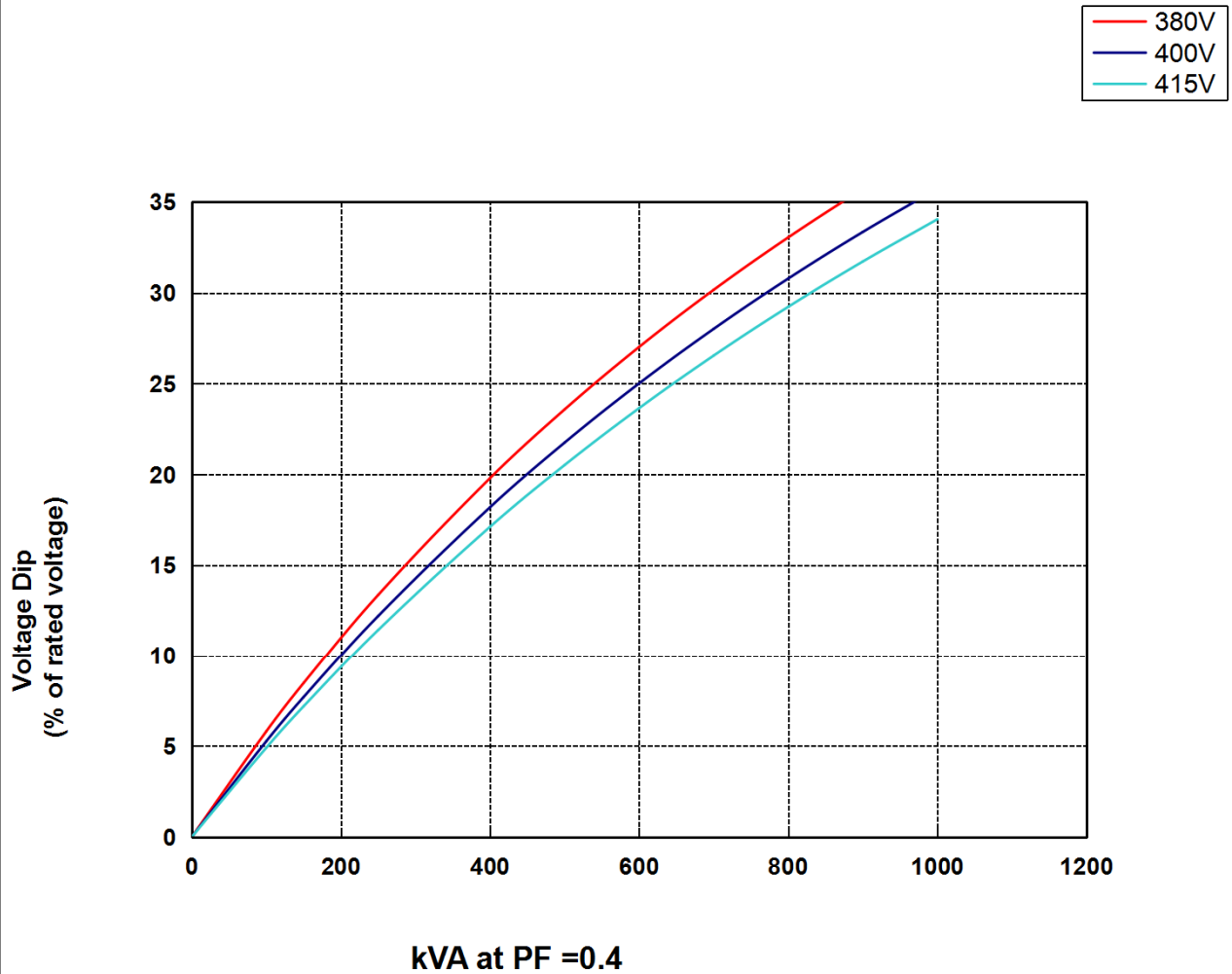



## THREE PHASE SYNCHRONOUS GENERATOR

### WHA-250-4/0.4

#### MOTOR STARTING CURVES (60Hz)

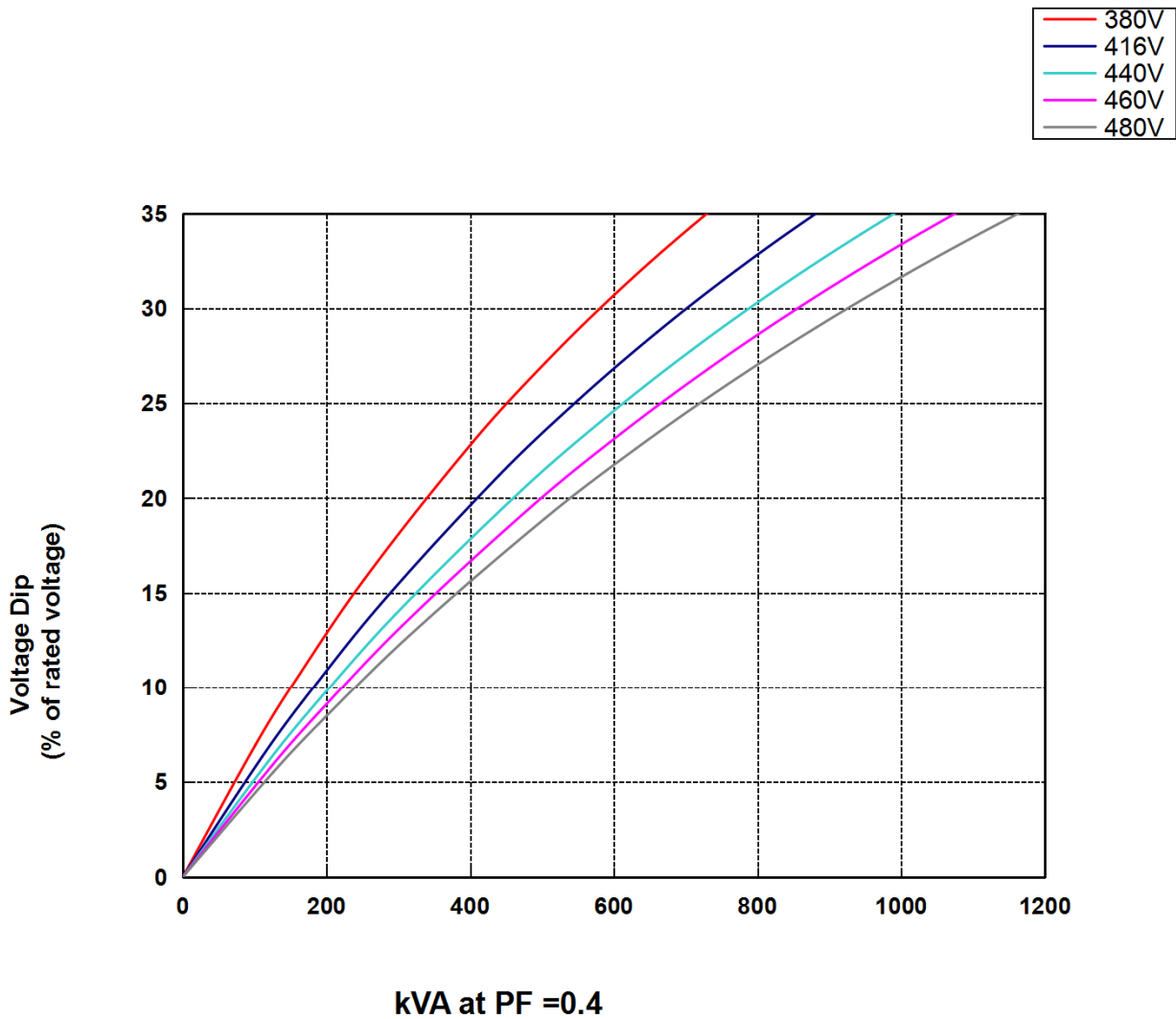



**WHC6100N SERIES**  
**(WHC6110N/6120N/6110NC/6120NC/6110CAN/6120CAN)**  
**GENSET CONTROLLER**  
**USER MANUAL**



**WEICHAI POWER CO., LTD.**

# PREFACE

All rights reserved. No part of this publication may be reproduced in any material form (including photocopying or storing in any medium by electronic means or other) without the written permission of the copyright holder.

Applications for the copyright holder's written permission to reproduce any part of this publication should be addressed to Weichai Power at the address above.

Any reference to trademarked product names used within this publication is owned by their respective companies.

Weichai Power reserves the right to change the contents of this document without prior notice.

Software Version,

Date	Version	Note
2018-01-15	1.0	Original release.

## CONTENTS

1	OVERVIEW.....	4
2	PERFORMANCE AND CHARACTERISTICS.....	4
3	SPECIFICATION.....	6
4	OPERATION.....	7
4.1	KEYS DSCRIPTION.....	7
4.2	CONTROLLER PANEL.....	8
4.3	AUTOMATIC START/STOP OPERATION.....	9
4.4	MANUAL START/STOP OPERATION.....	10
4.5	EMERGENCY START.....	10
5	PROTECTION.....	11
5.1	WARNINGS.....	11
5.2	SHUTDOWN ALARMS.....	12
6	CONNECTIONS.....	14
7	PARAMETER RANGE AND DEFINITION.....	16
7.1	PARAMETER CONTENT AND RANGE TABLE (TABLE 1).....	16
7.2	PROGRAMMABLE OUTPUT 1-4 TABLE (TABLE 2).....	22
7.3	PROGRAMMABLE INPUT 1-5 TABLE (TABLE 3).....	23
7.4	SENSOR SELECTION (TABLE 4).....	24
7.5	CONDITIONS OF CRANK DISCONNECT (TABLE 5).....	25
8	PARAMETER SETTING.....	26
9	SENSOR SETTING.....	27
10	COMMISSIONING.....	28
11	TYPICAL APPLICATION.....	29
12	INSTALLATION.....	32
12.1	FIXING CLIPS.....	32
12.2	OVERALL DIMENSION AND PANEL CUTOUT.....	32
13	CONNECTIONS OF CONTROLLER WITH J1939 ENGINE.....	33
14	FAULT FINDING.....	33



## 1 OVERVIEW

**WHC6100N** series automatic controller, integrating digital, intelligent and network techniques, is used for automatic control and monitoring system of genset. It can carry out functions of automatic start/stop, data measurement, alarm protection and three “remote” (remote control, remote measure and remote communication). The controller uses LCD display, optional display interface including Chinese, English, Spanish, Russian, Portuguese, Turkish, Polish and French with easy and reliable operation.

**WHC6100N** series automatic controller uses micro-processing technique which can achieve precision measurement, value adjustment, timing and threshold setting etc.. All the parameters can be configured from front panel or use USB interface (or RS485 interface) to adjust via PC. It can be widely used in all types of automatic control system for its compact structure, simple connections and high reliability.

## 2 PERFORMANCE AND CHARACTERISTICS

**WHC6100N** controller has six variants:

**WHC6110N/6110NC/6110CAN:** Automatic Start Module, it controls generator to start/stop by remote start signal;

**WHC6120N/6120NC/6120CAN:** Based on **WHC6110N/6110NC/6110CAN**, it adds mains AC monitoring and mains/generator automatic switching control (AMF), especially suitable for the automation system composed by mains and genset.

**Note1:** **WHC6110NC/6120NC** has RS485 port, **WHC6110N/6120N** without.

**WHC6110CAN/6120CAN** has CAN port, **WHC6110N/6120N** and **WHC6110NC/6120NC** without.

**Note2:** **WHC6110/6120** is taken as an example to describe in this manual.

- 132\*64 LCD display with backlight, optional language interface (Chinese, English, Spanish, Russian, Portuguese, Turkey, Polish and French), push-button operation;
- Acrylic screen, improved wearable and scratch resistance property;
- Silica-gel panel and keys can well adapt to higher and lower temperature;
- With RS485 communication port, can achieve “three remote” functions via MODBUS protocol;
- With CANBUS port which can be connected to electronic injection with J1939, it not only can monitor frequently-used data (such as water temperature, oil pressure, rotated speed and fuel consumption, etc.) but also can control start, stop, high speed and low speed (controller with CANBUS port is needed) via CANBUS port.
- Adapt to 3P4W, 3P3W, 1P2W and 2P3W (120V/240V), 50Hz/60Hz AC power system;
- Can measure and display 3 phase voltage, 3 phase current, frequency, power parameter of mains/gens;

### Mains

Line voltage (U<sub>ab</sub>, U<sub>bc</sub>, and U<sub>ca</sub>)

Phase voltage (U<sub>a</sub>, U<sub>b</sub>, and U<sub>c</sub>)

### Generator

Line voltage (U<sub>ab</sub>, U<sub>bc</sub>, and U<sub>ca</sub>)

Phase voltage (U<sub>a</sub>, U<sub>b</sub>, and U<sub>c</sub>)

Frequency HZ

Frequency HZ

**Load**

Current IA, IB, IC

Active power kW

Reactive power kvar

Apparent power kVA

Power factor PF

Generator accumulated energy kWh

Output percentage with load %

- Mains have functions of over/under voltage and lack of phase; Gens have functions of over/under voltage, over/under frequency, over current and over power;
- Precision measure and display of parameters about engine,
  - Temp. (WT), °C/ °F
  - Oil pressure (OP), kPa/psi/bar
  - Fuel level (FL), % Fuel remains L
  - Speed (SPD), r/min
  - Battery Voltage (VB), V
  - Charger Voltage (VD), V
  - Accumulative running hours
  - Accumulative start times
- Control protection: Automatic start/stop of genset, load transfer(ATS control) and perfect failure display and protection;
- With ETS, idle speed control, pre-heat control, speed droop/raising control, all of them are relay output;
- Parameter setting: Allow user to modify setting and store them in internal FLASH memory. The parameters cannot be lost even when power off. All of parameters can be set not only from the front panel, but also use USB interface (or PS485 interface) to adjust them via PC.;
- Multi sensors of temperature, pressure and fuel level can be used directly, parameters can be defined by user;
- Multi conditions of crank disconnect (speed sensor, oil pressure, generator) can be selected;
- With emergency start function;
- With flywheel teeth numbers automatic identification function;
- Power supply range: (8~35)VDC, accommodating to different starting battery volts;
- All parameters use digital modulation, instead of analog modulation using conventional potentiometer, having improved reliability and stability;
- With maintenance function. Types (date or running time) can be selected and actions (warning or alarm shutdown) can be set when maintenance time out;
- Event log, real-time clock, scheduled start & stop pump unit (can be set as start pump unit once a day/week/month whether with load or not);
- Add rubber gasket between shell and controller screen, the waterproof can reach IP55;





- Controller is fixed by metal fixing clips;
- Modular design, flame-retardant ABS shell, embedded mounting, compact structure and easy installation.

### 3 SPECIFICATION

Items	Contents
Working Voltage	DC8.0V to DC35.0V, continuous
Power Consumption	<3W(Standby mode: ≤2W)
AC System 3P4W 3P3W 1P2W 2P3W	AC15V - AC360 V (ph-N) AC30V - AC620 V (ph-ph) AC15V - AC360 V (ph-N) AC15V - AC360 V (ph-N)
AC Alternator Frequency	50Hz/60Hz
Rotate speed sensor Voltage	1.0V to 24V (RMS)
Rotate speed sensor Frequency	10,000 Hz (max.)
Start Relay Output	16 A DC28V at supply voltage
Fuel Relay Output	16 A DC28V at supply voltage
Auxiliary Relay Output 1	7 A DC28V at supply voltage
Auxiliary Relay Output 2	7 A AC250V volt-free output
Auxiliary Relay Output 3	16 A AC250V volt-free output
Auxiliary Relay Output 4	16 A AC250V volt-free output
Overall Dimensions	209mm x 166mm x 45mm
Panel Cutout	186mm x 141mm
C.T. Secondary Current	5A (rated)
Working Condition	Temperature: (-25~70)°C; Humidity: (20~90)%
Storage Condition	Temperature: (-30~+80)°C
Protection Level	IP55 Gasket
Insulation Intensity	Apply AC2.2kV voltage between high voltage terminal and low voltage terminal. The leakage current is not more than 3mA within 1min.
Weight	0.56kg

## 4 OPERATION

### 4.1 KEYS DSCRIPTION

Icon	Function	Description
	Stop/ Reset	Can stop generator under Manual/Auto mode; Can reset shutdown alarm; Press this key at least 3 seconds to test panel indicators are OK or not(lamp test); During stopping process, press this key again can stop generator immediately.
	Start	Start genset under Manual or Manual Test mode.
	Manual	Pressing this key will set the module as Manual mode.
	Auto	Pressing this key will set the module as Auto mode.
	Gens Close/Open	Can control gens to switch on or off in Manual mode. Note: the key is fit for WHC6120 series controllers.
	Close	Can control gens to switch on in Manual mode. Note: the key is fit for WHC6110 series controllers.
	Open	Can control gens to switch off in Manual mode. Note: the key is fit for WHC6110 series controllers.
	Set/ Confirm	Press this key to enter menu interface; Shift cursor to confirm In parameters setting menu.
	Up/Increase	Screen scroll; Up cursor and increase value in setting menu.
	Down/Decrease	Scroll screen; Down cursor and decrease value in setting menu.
	Home/Return	Return to homepage when in main interface; Exit when in parameters setting interface.



## 4.2 CONTROLLER PANEL



WHC6110 Front Panel



WHC6120 Front Panel

### Note: Partial indicator states

**Alarm Lamp:** slowly blink when warning alarms; fast blink when shutdown alarms; won't illuminate when there is no alarm.

**Status Lamp:** won't illuminate when genset stand by; blink 1 time in start or stop process and always illuminate when runs normally.

### 4.3 AUTOMATIC START/STOP OPERATION

Auto mode is activated by pressing the  , LED indicator beside the button is illuminating which confirms this action.









#### Starting Sequence,

- 1) **WHC6120**: When mains is abnormal (over/under voltage, lack of phase), enter into “Mains Abnormal Delay” and LCD displays count-down time. When delay is over, “Start Delay” begins.
- 2) **WHC6110**: when “remote start” input is active, enter into “Start Delay”.
- 3) “Count- down” of start delay is displayed in LCD.
- 4) When start delay is over, preheat relay is outputting (if configured), “Preheat Delay XX s” is displayed in LCD.
- 5) When preheat delay is over, fuel relay is outputting for 1s and then start relay outputs; if genset failed to start during “Crank Time”, the fuel and start relay stop outputting and enter into “Crank Rest Time” and wait for next cranking.
- 6) If genset failed to start within set start times, the fifth line of LED will turn black and Fail to Start alarm will be displayed.
- 7) Any time to start genset successfully, it will enter into “Safe Running”. During this period, alarms of low oil pressure, high temperature, under speed, Failed To Charge and Aux. input (be configured) are disabled. As soon as this delay is over, genset will enter into “Start Idle Delay” (if configured).
- 8) During start idle delay, alarms of under speed, under frequency, under voltage are disabled. As soon as this delay is over, genset will enter into “Warming up Delay” (if configured).
- 9) When “Warming up Delay” is over, the indicator is illuminating if gens normal. If voltage and frequency of engine reach the load requirement, close relay outputs, genset is taking load and indicator illuminates; if engine voltage or frequency is abnormal, controller will alarm and shutdown (LCD displays the alarm information).



#### Stopping Sequence,

- 1) **WHC6120**: during normal running, if mains normal, genset will enter into “Mains Normal Delay”, when mains indicator illuminates, “Stop Delay” begins.
- 2) **WHC6110**: genset enters into “Stop Delay” as soon as “Remote Start” is inactive.
- 3) When “Stop Delay” is over, genset enters into “Cooling Delay”. Closing relay is disconnected. After switch “Transfer Rest Delay”, closing relay is outputting, mains is taking load, generator indicator eliminates while mains indicator illuminates.
- 4) When entering “Stop Idle Delay”, idle relay is energized to output. (If configured).
- 5) When entering “ETS Delay”, ETS relay is energized to output, fuel relay output is disconnected.
- 6) When entering “Genset at Rest”, genset will automatically judge if it has stopped.
- 7) When genset has stopped, enter into standby mode; if genset failed to stop, controller will alarm (“Fail to Stop” alarm will be displayed in LCD).

#### 4.4 MANUAL START/STOP OPERATION

- 1) **WHC6120**, Auto Mode is active when press  and its indicator illuminates. Under both of the modes, press  to start genset, it can automatically detect crank disconnect and accelerate to high speed running. If there is high temperature, low oil pressure, over speed and abnormal voltage during genset running, controller can protect genset to stop (detail procedures please refer to No.4~9 of Auto start operation). Under Manual Mode, switch won't transfer automatically, it is necessary to press   to transfer load.
- 2) **WHC6110**, Auto Mode is active when pressing , and its indicator is illuminating. Then press  to start genset, it can automatically detect crank disconnect and accelerate to high speed running. If there is high temperature, low oil pressure, over speed and abnormal voltage during running, controller can protect genset to stop quickly (detail procedures please refer to No.4~9 of Auto start operation). After genset runs well in high speed, press  and gens take load.
- 3) Manual stop, pressing  can shut down the running genset (detail procedures please refer to No.3~7 of Auto stop operation).

#### 4.5 EMERGENCY START

In manual mode, pressing  and  can compel genset to start. The controller won't judge whether the controller has started successfully according to disconnect conditions and the disconnection of starter needs to control by operators. When operators observed the genset has started successfully, loose the keys and the controller enter safety delay with start stops to output.

## 5 PROTECTION

### 5.1 WARNINGS

When controller detects the warning signal, the genset only alarm and not stop. The alarms are displayed in LCD.

Warnings as following,

No.	Items	Description
1	Loss Of Speed Signal	When the speed of genset is 0 and speed loss delay is 0, controller will send warning alarm signal and it will be displayed in LCD.
2	Genset Over Current	When the current of genset is higher than threshold and setting over current delay is 0, controller will send warning alarm signal and it will be displayed in LCD.
3	Fail To Stop	When genset cannot stop after the "stop delay" is over, controller will send warning alarm signal and it will be displayed in LCD.
4	Low Fuel Level	When the fuel level of genset is lower than threshold or low fuel level warning is active, controller will send warning alarm signal and it will be displayed in LCD.
5	Failed To Charge	When the voltage of genset charger is lower than threshold, controller will send warning alarm signal and it will be displayed in LCD.
6	Battery Under Voltage	When the battery voltage of genset is lower than threshold, controller will send warning alarm signal and it will be displayed in LCD.
7	Battery Over Voltage	When the battery voltage of genset is higher than threshold, controller will send warning alarm signal and it will be displayed in LCD.
8	Low Coolant Level	When low coolant level input is active, controller will send warning alarm signal and it will be displayed in LCD.
9	Temp. Sensor Open	When sensor hasn't connected to corresponding port, controller will send warning alarm signal and it will be displayed in LCD.
10	Oil Pressure Sensor Open	When sensor hasn't connected to corresponding port, controller will send warning alarm signal and it will be displayed in LCD.
11	Maintenance Due Warning	When genset running time is longer than maintenance time of user setting, and the maintenance action is set as warning, controller send warning alarm signal and it will be displayed in LCD. When maintenance action type is set as "Not used", maintenance alarm reset.
12	High Temp.	When the water/cylinder temperature of genset is higher than threshold and Enabled High Temp. Stop Inhibited or Input High Temp. Stop Inhibited is active, controller will send warning alarm signal and it will be displayed in LCD.
13	Low Oil Pressure	When the oil pressure of genset is less than threshold and Enabled Low

No.	Items	Description
		Oil Pressure Stop Inhibited or Input Low Oil Pressure Stop Inhibited is active, controller will send warning alarm signal and it will be displayed in LCD.
14	Input Warn	When external input is active, controller will send warning alarm signal and it will be displayed in LCD.
15	Failed To Charge	When Failed To Charge input is active, controller will send warning alarm signal and it will be displayed in LCD.
16	Over Power	If over power detection is enabled, when the controller detects that the over power value (power is positive) has exceeded the pre-set value and the action select "Warn", it will initiate a warning alarm.
17	ECU Warn	If an error message is received from ECU via J1939, it will initiate a warning alarm.

## 5.2 SHUTDOWN ALARMS

When controller detects shutdown alarm, it will send signal to open switch and stop genset. The alarms are displayed in LCD.

Shutdown alarms as following,

No.	Items	Description
1	Emergency Stop	When controller detects emergency stop signal, it will send a stop alarm signal and it will be displayed in LCD.
2	High Temp. Shutdown	When the temperature of water/cylinder is higher than set threshold, controller will send a stop alarm signal and it will be displayed in LCD.
3	Low Oil Pressure Shutdown	When oil pressure is lower than threshold, controller will send a stop alarm signal and it will be displayed in LCD.
4	Over Speed Shutdown	When genset speed is higher than set threshold, controller will send a stop alarm signal and it will be displayed in LCD.
5	Under Speed Shutdown	When genset speed is lower than set threshold, controller will send a stop alarm signal and it will be displayed in LCD.
6	Loss Of Speed Signal Shutdown	When rotate speed is 0 and delay is not 0, controller will send a stop alarm signal and it will be displayed in LCD.
7	Genset Over Voltage Shutdown	When genset voltage is higher than threshold, controller will send a stop alarm signal and it will be displayed in LCD.
8	Genset Under Voltage Shutdown	When genset voltage is under set threshold, controller will send a stop alarm signal and it will be displayed in LCD.
9	Genset Over Current Shutdown	When genset current is higher than set threshold and delay is not 0, it will send a stop alarm signal and it will be displayed in LCD.

No.	Items	Description
10	Failed To Start	Within set start times, if failed to start, controller will send a stop alarm signal and it will be displayed in LCD.
11	Over Freq. Shutdown	When genset frequency is higher than set threshold, controller will send a stop alarm signal and it will be displayed in LCD.
12	Under Freq. Shutdown	When genset frequency is lower than set threshold, controller will send a stop alarm signal and it will be displayed in LCD.
13	Genset Failed	When genset frequency is 0, controller will send a stop alarm signal and it will be displayed in LCD.
14	Low Fuel Level	When fuel level low input is active, controller will send a stop alarm signal and it will be displayed in LCD.
15	Low Coolant Level	When genset coolant level low input is active, controller will send a stop alarm signal and it will be displayed in LCD.
16	Temp. Sensor Open	When sensor hasn't connected to corresponding port, controller will send shutdown alarm signal and it will be displayed in LCD.
17	Oil Sensor Open	When sensor hasn't connected to corresponding port, controller will send shutdown alarm signal and it will be displayed in LCD.
18	Maintenance shutdown	When genset running is longer than maintenance time of user setting, and maintenance action is set as shutdown, controller send shutdown alarm signal and it will be displayed in LCD. When maintenance action type is set as "Not used", maintenance alarm reset.
19	Input Shutdown	When external input is active, controller will send shutdown alarm signal and it will be displayed in LCD.
20	Over Power	If over power detection is enabled, when the controller detects that the over power value (power is positive) has exceeded the pre-set value and the action select "Shutdown", it will initiate a shutdown alarm.
21	ECU Shutdown	If an error message is received from ECU via J1939, it will initiate a shutdown alarm.
22	ECU Fail	If the module does not detect the ECU data, it will initiate a shutdown alarm.

**▲Note: ECU warning and Shutdown alarm explains that check genset according to displayed alarm contents; otherwise check engine user manual according to SPN alarm code for gaining information.**



## 6 CONNECTIONS

Compared with WHC6120, WHC6110 doesn't have 3-phase input terminal of mains voltage. The back panel of WHC6120 is as below.

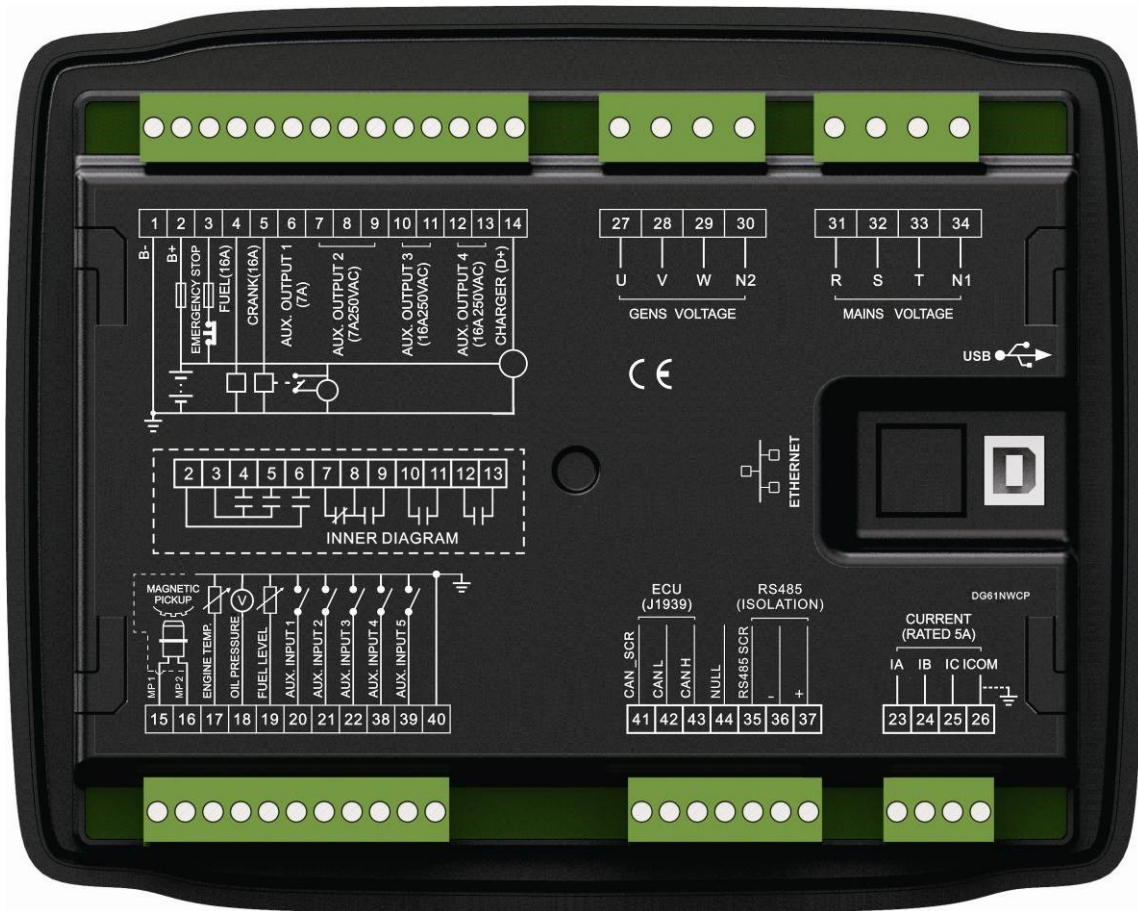

Descriptions of terminal connection as following,

No.	Function	Cable Size	Description
1	DC input B-	2.5mm <sup>2</sup>	Connected to negative of starter battery
2	DC input B+	2.5mm <sup>2</sup>	Connected to positive of starter battery. If wire length is over 30m, better to double wires in parallel. Max. 20A fuse is recommended.
3	Emergency Stop	2.5mm <sup>2</sup>	Connected to B+ via emergency stop button.
4	Fuel Relay Output	1.5mm <sup>2</sup>	B+ is supplied by 3 points, rated 16A
5	Start Relay Output	1.5mm <sup>2</sup>	B+ is supplied by 3 points, rated 16A Connect to starter coil
6	Aux. Relay Output 1	1.5mm <sup>2</sup>	B+ is supplied by 2 points, rated 7A
7	Aux. Relay Output 2	1.5mm <sup>2</sup>	Normal close output, 7 A rated.
8			Relay common port
9			Normal open output, 7 A rated.
10	Aux. Relay Output 3	2.5mm <sup>2</sup>	Relay normal open volt-free contact output
11	Aux. Relay Output 4	2.5mm <sup>2</sup>	
12			
13			
14	Charging Generator D+ Input	1.0mm <sup>2</sup>	Connect to D+ (WL) terminal. If without, the terminal is not connected.
15	Speed sensor input	0.5mm <sup>2</sup>	Connected to Speed sensor, shielding line is

Reference **Table 2**

No.	Function	Cable Size	Description	
16	Speed sensor input, B- is connected.		recommended.	
17	Temp. Sensor Input	1.0mm <sup>2</sup>	Connect to water /cylinder temp. resistance type sensor	Reference <b>Table 4</b>
18	Oil Pressure Sensor Input	1.0mm <sup>2</sup>	Connect to oil pressure 0-5V resistor type sensor	
19	Liquid Level Sensor Input	1.0mm <sup>2</sup>	Connect to liquid level resistance type sensor	
20	Configurable Input 1	1.0mm <sup>2</sup>	Ground connected is active (B-)	Reference <b>Table 3</b>
21	Configurable Input 2	1.0mm <sup>2</sup>	Ground connected is active (B-)	
22	Configurable Input 3	1.0mm <sup>2</sup>	Ground connected is active (B-)	
23	CT A Phase Sensing Input	1.5mm <sup>2</sup>	Connect secondary coil, rated 5A	
24	CT B Phase Sensing Input	1.5mm <sup>2</sup>	Connect secondary coil, rated 5A	
25	CT C Phase Sensing Input	1.5mm <sup>2</sup>	Connect secondary coil, rated 5A	
26	CT Common Port	1.5mm <sup>2</sup>	Refer to INSTALLATION description.	
27	Generator U phase Voltage Sensing Input	1.0mm <sup>2</sup>	Connect to U phase output(2A fuse is recommended)	
28	Generator V phase Voltage sensing Input	1.0mm <sup>2</sup>	Connect to V phase output(2A fuse is recommended)	
29	Generator W phase Voltage Sensing Input	1.0mm <sup>2</sup>	Connect to W phase output(2A fuse is recommended)	
30	Generator N2 Input	1.0mm <sup>2</sup>	Connect to generator N-wire	
31	Mains R phase Voltage Sensing Input	1.0mm <sup>2</sup>	Connect to mains R phase(2A fuse is recommended) <b>WHC6110</b> without	
32	Mains S phase Voltage Sensing Input	1.0mm <sup>2</sup>	Connect to mains S phase (2A fuse is recommended) <b>WHC6110</b> without.	
33	Mains T phase Voltage Sensing Input	1.0mm <sup>2</sup>	Connect to mains T phase, (2A fuse is recommended) <b>WHC6110</b> without.	
34	Mains N1 Input	1.0mm <sup>2</sup>	Connect to mains N-wire, <b>WHC6110</b> without.	
35	RS485 Common Ground	/	Impedance-120Ω shielding wire is recommended, its single-end connect with ground.	
36	RS485 -	0.5mm <sup>2</sup>		
37	RS485+	0.5mm <sup>2</sup>		
38	Configurable Input 4	1.0mm <sup>2</sup>	Ground connected is active (B-)	Reference <b>Table 3</b>
39	Configurable Input 5	1.0mm <sup>2</sup>	Ground connected is active (B-)	
40	Sensor Common	1.0mm <sup>2</sup>	Sensor common port	
41	CAN COM	0.5mm <sup>2</sup>	Impedance-120Ω shielding wire is recommended, its single-end connect with ground (the controller without CANBUS function doesn't have this terminal).	
42	CAN L	0.5mm <sup>2</sup>		
43	CAN H	0.5mm <sup>2</sup>		
44	NULL			

 **Note:** USB ports in controller rear panel are programmable parameter ports; user can directly program via PC.

## 7 PARAMETER RANGE AND DEFINITION

### 7.1 PARAMETER CONTENT AND RANGE TABLE (TABLE 1)

Content and range of parameters,

No.	Items	Range	Default	Description
1	Mains Normal Delay	(0-3600)s	10	The delay from abnormal to normal or from normal to abnormal. It used for ATS (automatic transfer switch) control.
2	Mains Abnormal Delay	(0-3600)s	5	
3	Mains Under Voltage	(30-620)V	184	When mains voltage is under the point, mains under voltage active. When the value is 30, mains under voltage disabled.
4	Mains Over Voltage	(30-620)V	276	When mains voltage is greater than the point, mains over voltage active. When the point is 620V, mains over voltage disabled.
5	Transfer Rest Time	(0-99.9)s	1.0	It's the delay from mains open to generator closed or from generator open to mains closed.
6(1)	Start Delay	(0-3600)s	1	Time from mains abnormal or remote start signal is active to start genset.
7(2)	Stop Delay	(0-3600)s	1	Time from mains normal or remote start signal is inactive to genset stop.
8(3)	Start Times	(1-10) times	3	When engine start failure, it's the maximum cranking times. When setting crank times out, controller send start fail signal.
9(4)	Preheat Time	(0-300)s	0	Time of pre-powering heat plug before starter is powered up.
10(5)	Crank Time	(3-60)s	8	Time of starter power up each time.
11(6)	Crank Rest Time	(3-60)s	10	The second waiting time before power up when engine start fail.
12(7)	Safe Running Time	(1-60)s	10	Alarm for low oil pressure, high temp, under speed, under frequency /voltage, Failed To Charge are all inactive.
13(8)	Start Idle Time	(0-3600)s	0	Idle running time of genset when starting.
14(9)	Warming Up Time	(0-3600)s	10	Warming time between genset switch on and high speed running.
15(10)	Coolant Time	(3-3600)s	10	Time for cooling before stopping.
16(11)	Stop Idle Time	(0-3600)s	0	Idle running time when genset stop.
17(12)	ETS Time	(0-120)s	20	Stop electromagnet's power on time when genset is stopping.
18(13)	Over Stop Delay	(0-120)s	0	If "ETS output time" set as 0, it is the time from end of idle delay to gen-set at rest; if not 0, it is from end of ETS solenoid delay to gen-set at rest

No.	Items	Range	Default	Description
19(14)	Switch Close Delay	(0-10)s	5.0	Mains' or generator's switch closing pulse width, when it is 0, output is continuous.
20(15)	Flywheel Teeth	(10-300)	118	Number of flywheel teeth, it can detect disconnection conditions and engine speed.
21(16)	Genset Abnormal Delay	(0-20.0)s	10.0	Over or under volt alarm delay
22(17)	Genset Over Voltage shutdown	(30-620)V	264	When genset voltage is over the point, generator over voltage is active. When the point is 620V, generator over voltage is disabled.
23(18)	Genset Under Voltage	(30-620)V	196	When generator voltage is under the point, generator under voltage is active. When the point is 30V, generator under voltage is disabled.
24(19)	Under Speed shutdown	(0-6000)r/min	1200	When the engine speed is under the point for 10s, shutdown alarm signal is sent out.
25(20)	Over Speed shutdown	(0-6000)r/min	1710	When the engine speed is over the point for 2s, shutdown alarm signal is sent.
26(21)	Under Frequency shutdown	(0-75.0)Hz	45.0	When generator frequency is lower than the point (not equal to 0) for 10s, shutdown alarm signal is sent.
27(22)	Over Frequency shutdown	(0-75.0)Hz	57.0	When generator's frequency is over the point and continues for 2s, generator over frequency is active.
28(23)	High Temperature shutdown	(80-140)°C	98	When engine temperature sensor value is over this point, it sends out high temp. alarm. When the value is 140, warning alarm won't be sent. (only suited for temperature sensor, except for high temp. pressure alarm signal inputted by programmable input port )
29(24)	Low Oil Pressure shutdown	(0-400)kPa	103	When engine oil pressure sensor value is under this point, Low Oil Pressure alarm is sending out. When the value is 0, warning alarm won't be sent. (only suited for oil pressure sensor, except for low oil pressure alarm signal inputted by programmable input port)
30(25)	Low Fuel Level	(0-100)%	10	When fuel level sensor value under this point and remains for 10s, genset send out warning alarm, only warn but not shutdown.
31(26)	Loss Of Speed Signal Delay	(0-20.0)s	5.0	When the delay setting as 0s, it only warn but not shutdown

No.	Items	Range	Default	Description
32(27)	Failed To Charge	(0-30)V	6.0	During generator is running, when charge alternator WL/D+ voltage is under this point and remain for 5s, generator will warning alarm and shutdown.
33(28)	Battery Over Voltage	(12-40)V	33.0	When generator battery voltage is over the point and remains for 20s, battery over voltage signal is active. it only warn but not shutdown
34(29)	Battery Under Voltage	(4-30)V	8.0	When generator battery voltage is under the point and remains for 20s, battery under voltage signal is active. it only warn but not shutdown
35(30)	CT Rate	(5-6000)/5	500	Current transformer rate
36(31)	Full Load Current	(5-6000)A	500	Rated current of generator, used for calculating over load current.
37(32)	Over Current Percentage	(50-130)%	120	When load current is over the point, the over current delay is initiated.
38(33)	Over Current Delay	(0-3600)s	30	When load current is over the point, over current signal is sent. When the delay is 0, only warn but not shutdown.
39(34)	Fuel Pump Open	(0-100)%	25	When the fuel level lower than the set value for 10s, send a signal to open fuel pump.
40(35)	Fuel Pump Close	(0-100)%	80	When the fuel level higher than the set value for 10s, send a signal to close fuel pump.
41(36)	Aux. Output 1	(0-23)	2	Factory default: Energized to stop. See 7.2
42(37)	Aux. Output 2	(0-23)	3	Factory default: Idle control. See 7.2
43(38)	Aux. Output 3	(0-23)	5	Factory default: Gens closed. See 7.2
44(39)	Aux. Output 4	(0-23)	6	Factory default: Mains closed. See 7.2
45(40)	Aux. Input 1	(0-19)	1	Factory default: High temperature alarm. See 7.3
46(41)	Aux. Input 1 Active	(0-1)	0	Factory default: close
47(42)	Aux. Input 1 Delay	(0-20.0)s	2.0	
48(43)	Aux. Input 2	(0-19)	2	Factory default: Low oil pressure alarm. See 7.3
49(44)	Aux. Input 2 Active	(0-1)	0	Factory default: close
50(45)	Aux. Input 2 Delay	(0-20.0)s	2.0	
51(46)	Aux. Input 3	(0-19)	10	Factory default: Remote start input. See 7.3
52(47)	Aux. Input 3 Active	(0-1)	0	Factory default: close
53(48)	Aux. Input 3 Delay	(0-20.0)s	2.0	
54(49)	Aux. Input 4	(0-19)	11	Factory default: Low fuel level warn. See 7.3
55(50)	Aux. Input 4 Active	(0-1)	0	Factory default: close
56(51)	Aux. Input 4 Delay	(0-20.0)s	2.0	
57(52)	Aux. Input 5	(0-19)	12	Factory default: Low coolant level warn. See 7.3
58(53)	Aux. Input 5 Active	(0-1)	0	Factory default: close
59(54)	Aux. Input 5 Delay	(0-20.0)s	2.0	



No.	Items	Range	Default	Description
60(55)	Power Mode Select	(0-2)	0	0: Stop Mode; 1: Manual Mode; 2: Auto Mode
61(56)	Module Address	(1-254)	1	The address of controller.
62(57)	Password	(0-9999)	0318	See Note 4
63(58)	Crank Disconnect Condition	(0-6)	2	Conditions of disconnecting starter (generator, magnetic pickup sensor, oil pressure), Each condition can be used alone and simultaneously to separating the start motor and genset as soon as possible.
64(59)	Engine Speed	(0-6000)r/min	360	When engine speed is over this point, starter will disconnect.
65(60)	Engine Frequency	(10-30)Hz	14	When generator frequency is over this point, starter will disconnect.
66(61)	Engine Oil Pressure	(0-400)kPa	200	When engine oil pressure is over this point, starter will disconnect.
67(62)	High Temp. Inhibit Select	(0-1)	0	Default: when temperature is overheat, the genset alarm and shutdown. <b>Note1</b>
68(63)	Low OP Inhibit Select	(0-1)	0	Default: when oil pressure is too low, it alarm and shutdown. <b>Note2</b>
69(64)	AC Wire	(0-3)	0	0: 3P4W 1: 2P3W 2: 1P2W 3: 3P3W
70(65)	Temp. Sensor Select	(0-12)	8	SGX See 7.4
71(66)	Pressure Sensor Select	(0-14)	14	Selecting "10" means user-defined 0-5V curve; Selecting "14" means fixed 0-5V curve.
72(67)	Liquid Level Sensor Select	(0-7)	3	SGD See 7.4
73(68)	Poles Number	(2-64)	4	Number of magnetic poles, used for calculating rotating speed of generator without speed sensor.
74(69)	Temp. Sensor Open Circuit Action	(0-2)	1	0: Indication; 1: Warning; 2: Shutdown
75(70)	Oil Pressure Sensor Open Circuit Action	(0-2)	1	
76(71)	Disconnect Oil Pressure Delay	(0-20.0)s	0.0s	When disconnect conditions include oil pressure and engine oil pressure is higher than disconnect oil pressure delay, the genset is regarded as start successfully and starter will disconnect.
77(72)	Timing Start	(0-1)	0	0:Disabled; 1:Enabled.
78(73)	Timing Start Circulate	(0-1)	0	Circulate condition: monthly, weekly and daily can be selected. Start time and duration can be set.
79(74)	Auto Start Inhibited	(0-1)	0	0:Disabled; 1:Enabled.



No.	Items	Range	Default	Description
80(75)	Auto Start Circulate Inhibited	(0-2)	0	Circulate condition: monthly, weekly and daily can be selected. Don't start time and duration can be set.
81(76)	Over Power	(0-2)	0	0 Inactive; 1 Warn; 2 Alarm Shutdown When power is higher than preset value and duration exceeds than delay, over power warning is active. Return and delay value can be set.
82(77)	Start Interface	(0-1)	0	0:Disabled; 1:Enabled. Start interface delay can be set.
83(78)	Maintenance Password	(0-9999)	0	Enter password interface of maintenance configuration.
84(79)	Date	Set the date of controller.		

## Content of WHC6100N/WHC6100NC parameters,

No.	Items	Range	Default	Description
85(80)	Fuel Output Time	(1-60)s	1	It is output time of fuel relay.
86(81)	ATS Actions in Manual Mode	(0-1)	0	0: Key Press Transfer; 1: Auto Transfer ATS actions when controller is in manual mode.
87(82)	Rise Speed Pulse Time	(0-20.0)s	0.2	It is output time when output port is configured as "24 Rise Speed Pulse Output".
88(83)	Drop Speed Pulse Time	(0-20.0)s	0.2	It is output time when output port is configured as "25 Drop Speed Pulse Output".
89(84)	Low Fuel Level Shutdown Limit	(0-100)%	5	Genset shuts down when fuel level sensor falls below the setting limit and delay time lasts for over 5s.
90(85)	ATS Open Time	(1.0-60.0)s	3.0	It is open ATS output time.
91(86)	Gen Voltage Transformer Ratio	(0-1)	0	0:Disabled; 1:Enabled Setting generator voltage transformer ratio.
92(87)	Mains Voltage Transformer Ratio	(0-1)	0	0:Disabled; 1:Enabled Setting mains voltage transformer ratio.
93(88)	User-defined Sensor Curve Input	(0-2)	0	0 User-defined temperature sensor; 1 User-defined pressure sensor; 2 User-defined fuel level sensor; Selecting the sensor that to be configured, and entering the resistance (current or voltage) of each point and the corresponding values (8 points need to be entered).

Content of WHC6100CAN parameters,

No.	Items	Range	Default	Description
85(80)	User-defined Sensor Curve Input	(0-2)	0	0 User-defined temperature sensor; 1 User-defined pressure sensor; 2 User-defined fuel level sensor; Selecting the sensor that to be configured, and entering the resistance (current or voltage) of each point and the corresponding values (8 points need to be entered).
86(81)	Engine Type Selection	(0-39)	0	Default as conventional genset.
87(82)	SPN Alarm Version	(1-3)	0	Alarm version 1
88(83)	User-defined Interface	(0-2)	0	0: Factory default interface 1: OEM factory interface 2: Terminal user interface
89(84)	Fuel Output Time	(1-60)s	1	It is output time of fuel relay.
90(85)	ATS Actions in Manual Mode	(0-1)	0	0: Key Press Transfer; 1: Auto Transfer ATS actions when controller is in manual mode.
91(86)	Rise Speed Pulse Time	(0-20.0)s	0.2	It is output time when output port is configured as "24 Rise Speed Pulse Output".
92(87)	Drop Speed Pulse Time	(0-20.0)s	0.2	It is output time when output port is configured as "25 Drop Speed Pulse Output".
93(88)	Low Fuel Level Shutdown Limit	(0-100)%	5	Genset shuts down when fuel level sensor falls below the setting limit and delay time lasts for over 5s.
94(89)	ATS Open Time	(1.0-60.0)s	3.0	It is open ATS output time.
95(90)	Gen Voltage Transformer Ratio	(0-1)	0	0:Disabled; 1:Enabled Setting generator voltage transformer ratio.
96(91)	Mains Voltage Transformer Ratio	(0-1)	0	0:Disabled; 1:Enabled Setting mains voltage transformer ratio.

**▲Note1:** The default value in "Number" column is for WHC6120 and the value in brackets is for WHC6110.

**▲Note2:** if select high temperature inhibit, or set programmable input as High Temperature Inhibit ( this input is active), when temperature is higher than pre-setting threshold or high temperature alarm is activated, controller sends warning signal only and not shutdown.

**▲Note3:** if select low oil pressure inhibit, or set programmable input as Low Oil Pressure Inhibit ( this input is active), when low oil pressure is lower than pre-setting threshold or low oil pressure alarm is activated, controller sends warning signal only and not shutdown.

**▲Note4:** If default password (0318) isn't changed, it doesn't need to input when configuring parameters via PC software; if the password is changed for the first time via PC software, it need to input password in password window.

**▲Note5:** Between input correct password and LCD back light haven't got dark, input parameter numbers can

enter parameter setting interface when enters “Password Input” again.

**▲Note6:** In teeth configuration interface, if being in teeth configuration status and frequency is larger than 20Hz, press start key for auto calculating teeth numbers and press confirm key for changing teeth numbers.

**▲Note7:** “Content and range of parameters” table contains all WHC6100 series parameters with the same number; “Content of WHC6100N/WHC6100NC parameters” table contains parameters of WHC6100N/WHC6100NC series controllers; “Content of WHC6100CAN parameters” table contains parameters of WHC6100CAN series controllers





## 7.2 PROGRAMMABLE OUTPUT 1-4 TABLE (TABLE 2)





No.	Items	Description
0	Not Used	Output is disabled when this item is selected.
1	Common Alarm	Including all shutdown alarm and warning alarm. When a warning alarm occurs, the alarm won't self-lock; When a shutdown alarm occurs, the alarm will self-lock until alarm is reset.
2	ETS Control	Used for the genset with stop solenoid. Pick-up when idle speed is over while disconnect when ETS delay is over.
3	Idle Control	Used for the genset with idle speed. Pick-up when crank while disconnect when enter into warming up. Pick-up when stop idle while disconnect when genset stop completely.
4	Preheat Control	Close before started and disconnect before powered on.
5	Gens Close	When close time is set as 0, it is continuous closing.
6	Mains Close	<b>WHC6110</b> without.
7	Open Breaker	When close time is set as 0, Open Breaker is disabled.
8	Accelerate Control	Pick-up when enter into warming up time. Disconnect when raise speed auxiliary input active.
9	Decelerate Control	Pick-up when enter into stop idle or ETS solenoid stop (shutdown alarm). Disconnect when droop speed auxiliary input active.
10	Genset Run Output	Output when genset is in normal running, disconnect when rotating speed is lower than engine speed after fired.
11	Fuel Pump Control	Pick-up when the fuel level lower than the open threshold or low fuel level warning is active; disconnect when the fuel level over the close threshold and the low fuel level warning input is disabled.
12	High Speed Control	Output when it enter into warming up time, and disconnect after cooling.
13	System In Auto Mode	The controller is in Auto Mode.
14	Shutdown Alarm	Output when shutdown alarm occurs and open when alarm resets.
15	Audible Alarm	When shutdown alarm and warn alarm, audible alarm is set as 300s. In audible alarm output duration, when panel any key or “alarm mute” input is active, it can remove the alarm.
16	Coolant Control	It is controlled by cooler of temperature sensor's limited threshold.
17	Fuel Relay	Action when genset is starting and disconnect when stop is completed.

No.	Items	Description
18	Start Relay	Genset output in start output status and open in other status.
19	ECU Stop	Used for ECU engine and control its stop.
20	ECU Power Supply	Used for ECU engine and control its power.
21	ECU Warning	Indicate ECU sends a warning signal.
22	ECU Shutdown	Indicate ECU sends a shutdown signal.
23	ECU Com Fail	Indicate controller not communicates with ECU.

### 7.3 PROGRAMMABLE INPUT 1-5 TABLE (TABLE 3)

(All Is Active When Connect To Ground (B-))

No.	Items	Description
0	Not Used	
1	High Temp. Alarm	If the signal is active after safety run on delay over, genset will immediately alarm to shutdown.
2	Low OP Alarm	
3	Auxiliary Alarm	Only warn, not shutdown.
4	Aux. Shutdown Alarm	If the signal is active, genset will immediately alarm to shutdown.
5	Coolant To Stop	During engine running and the input is active, if high temperature occurs, controller will stop after high speed cooling; when the input is disabled, controller will stop immediately.
6	Gens Closed Input	Connect to auxiliary port of gen load breaker.
7	Mains Closed Input	Connect to auxiliary port of mains load breaker.
8	High Temp. Inhibit	When it is active, high oil temperature stop is inhibited. See <b>Note2 of Table1</b> for more information.
9	Low Oil Pressure Inhibit	When it is active, low oil pressure stop is inhibited. See <b>Note3 of Table1</b> for more information.
10	Remote Start Input	In <b>Auto</b> mode, when input active, genset can be started and with load after genset is OK; when input inactive, genset will stop automatically.
11	Low Fuel Level Warn	Connected to sensor digital input. The controller sends an warning alarm signal when active.
12	Low Water Level Warn	
13	Low Fuel Level Shutdown	Connected to sensor digital input. The controller sends an shutdown alarm signal when active.
14	Low Water Level Shutdown	
15	Auto Start Inhibit	In Auto Mode, when the input is active, no matter mains normal or not, genset won't start. If genset is in normal running, stop process won't be executed. When input is disabled, genset will automatically start or stop judging by mains normal or not.
16	Remote Control Input	All buttons in panel is inactive except     and Remote Mode is displayed on LCD. Remote module can switch module mode and start/stop operation via panel buttons.
17	Failed To Charge	Connect to failed to charge output.

No.	Items	Description
18	Panel Lock	All buttons in panel is inactive except     and there is  in the left of fifth row in LCD when input is active.
19	Alarm Mute	Can prohibit “Audible Alarm” output when input is active.

#### 7.4 SENSOR SELECTION (TABLE 4)

No.	Items	Content	Description
1	Temperature Sensor	0 Not used 1 Defined Resistor Type 2 VDO 3 SGH 4SGD 5 CURTIS 6 DATCON 7 VOLVO-EC 8 SGX 9 User-defined 4-20mA 10 User-defined 0-5V 11 Low Digit Input Active 12 High Digit Input Active 13 Reserved 14 Reserved	Defined input resistance range is 0Ω~6000Ω, factory default is SGX sensor.
2	Pressure Sensor	0 Not used 1 Reserved 2 Reserved 3 Reserved 4 Reserved 5 Reserved 6 Reserved 7 Reserved 8 Reserved 9 Reserved 10 User-defined 0-5V 11 Low Digit Input Active 12 High Digit Input Active 13 Reserved 14 WEICHAI 0-5V	Defined input voltage range is 0-5V.
3	Fuel Level Sensor	0 Not used 1 Defined Resistor Type 2 SGH 3 SGD 4 User-defined 4-20mA	Defined input resistance range is 0~6000Ω, factory default is SGD sensor.

No.	Items	Content	Description
		5 User-defined 0-5V 6 Low Digit Input Active 7 High Digit Input Active	

**▲Note:** it needs special instructions for ordering when the genset use 4-20mA or 0-5V sensors.

### 7.5 CONDITIONS OF CRANK DISCONNECT (TABLE 5)

No.	Content
0	Speed
1	Generator frequency
2	Speed + Generator frequency
3	Speed + Oil pressure
4	Generator frequency + Oil pressure
5	Generator frequency + Speed + Oil pressure
6	Oil pressure

- 1) There are 3 kinds of crank disconnect conditions. Speed, Generator frequency and Oil pressure can be used alone. Oil pressure is used with speed and the generator frequency together is recommended, in order to make the starter and the engine disconnect as soon as possible.
- 2) Speed is the signal measured by magnetic sensor, which is installed in the engine for testing flywheel teeth.
- 3) When choosing speed, ensure the number of flywheel teeth is same as the pre-set, otherwise over or under speed shutdown may appear.
- 4) If generator has no magnetic pickup sensor, don't choose speed item; otherwise Fail to Start or Loss of Speed Signal shutdown will occur.
- 5) If the generator has no oil pressure sensor, don't choose corresponding item.
- 6) If generator frequency has not been selected, controller will not measure and display the relative parameters (can be applied to the pump set); if speed has not been selected, the rotating speed will be calculated by the generating AC signal.

## 8 PARAMETER SETTING

After controller powered on, press  to enter into the parameters setting menu:

- 1) Parameters Setting
- 2) Information
- 3) Language
- 4) Event Log
- 5) Maintenance Setting

### a) Parameters Setting

“0318” can set all items in table1 during inputting password. When default password has been changed, it needs to input the same password with controller for parameter setting via PC software. If more parameter items need to be set or password is forgotten, such as voltage and current calibration, please contact with the factory.

#### **Note:**

- 1) **WHC6110**, there are not items 1-5 in table1; programmable output 1-4 have no digital outputs about mains.
- 2) Please modify the parameters in standby mode (crank conditions, auxiliary input and output configuration, multi delays, etc.) otherwise shutdown alarm or other abnormal conditions may appear.
- 3) The over-voltage threshold must be greater than the under-voltage threshold; otherwise over-voltage and under-voltage will occur at the same time.
- 4) The over-speed threshold must be greater than under-speed threshold, otherwise over speed and under speed will occur at the same time.
- 5) Set frequency value (after crank disconnect) as low as possible, in order to disconnect starter quickly.
- 6) Programmable input 1-5 cannot be set as the same items, otherwise it cannot realize correct function; programmable output 1-4 can be set as the same item.
- 7) If need to shut down after cooling, please set any input as “ stop after cooling “, then connect this input to ground; or set high temperature stop action as “cooling stop”

### b) Information





LCD will display some information of controller, such as software version, issue date.

 **Note:** Pressing  will display the status of digital inputs and outputs.

### c) Language

User may select display language as Chinese, English, Spanish, Russian, Portuguese, Turkey, Polish and French.

### d) LCD contract

Press  and  (or  and ) can adjust LCD contract. Adjustment range is 0-7.



## 9 SENSOR SETTING

- 1) When choosing sensor, standard of sensor curve will be needed. If temperature sensor is set as SGH (120°C resistor type), sensor curve should be SGH (120°C resistor type); If it is set as SGD (120°C resistor type), sensor curve should be SGD curve.
- 2) If there is difference between standard sensor curve and chosen sensor curve, select “defined sensor”, and then input defined sensor curve.
- 3) When sensor curve is inputted, X value (resistance) must be in accordance with the order of higher to lower, otherwise errors will occur.
- 4) When sensor is selected as “Not used”, temperature, pressure and fuel level will be display as “ - - - ” in LCD.
- 5) If there is no pressure sensor, but only has low pressure alarm switch, then you must set pressure sensor as “Not used”, otherwise oil pressure low alarm shutdown may appear.
- 6) Can set several points of forehead or backmost as the same ordinate, as the following picture:

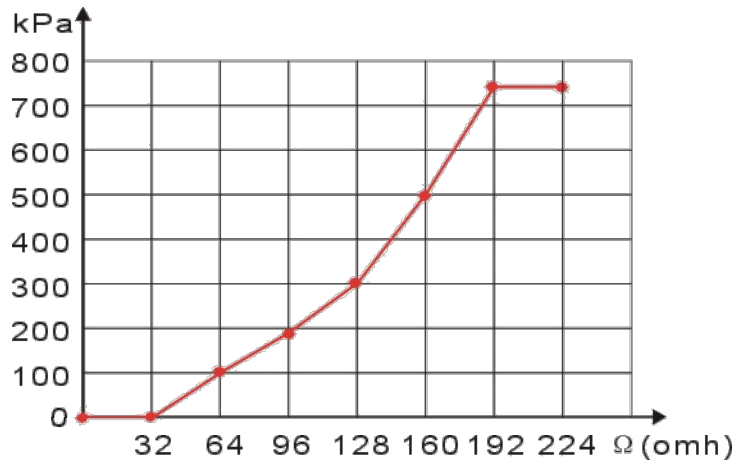

**Conventional pressure unit conversion table**

	1N/m <sup>2</sup> (pa)	1kgf/cm <sup>2</sup>	1bar	(1b/in <sup>2</sup> ) psi
1Pa	1	1.02x10 <sup>-5</sup>	1x10 <sup>-5</sup>	1.45x10 <sup>-4</sup>
1kgf/cm <sup>2</sup>	9.8x10 <sup>4</sup>	1	0.98	14.2
1bar	1x10 <sup>5</sup>	1.02	1	14.5
1psi	6.89x10 <sup>3</sup>	7.03x10 <sup>-2</sup>	6.89x10 <sup>-2</sup>	1

## 10 COMMISSIONING

Before operation, the following checking should be carried out:

- 1) Check and ensure all the connections are correct and wires diameter is suitable.
- 2) Ensure that the controller DC power has fuse; battery positive and negative have correctly connected.
- 3) Emergence stop input must be connected to positive of starting battery via normally close contact of emergency stop.
- 4) Take proper actions to prevent engine to disconnect crank (e. g. Remove the connections of fuel value). If checking is OK, connect start battery, select Manual Mode, controller will execute the program.
- 5) Set controller as Manual Mode, press “start” button to start genset. If failed within the setting crank times, controller will send “Failed to Start” signal; then press “stop” to reset controller.
- 6) Recover actions of preventing engine to disconnect crank (e. g. Connect wire of fuel value), press “start” button again, genset will start. If everything goes well, genset will normal run after idle running (if configured). During this period, watch for engine’s running situations and voltage and frequency of alternator. If there is abnormal, stop genset and check all connections according to this manual.
- 7) Select the Auto Mode from front panel, connect to mains signal. After the mains normal delay, controller will transfer ATS (if configured) into mains load. After cooling, controller will stop genset and into standby state until mains abnormal again.
- 8) When mains abnormal again, genset will start automatically and into normal running, send signal to make gens close, transfer ATS and make genset take load. If it not likes this, please check connections of ATS according to this manual.
- 9) If there are any other questions, please contact factory service.

11 TYPICAL APPLICATION

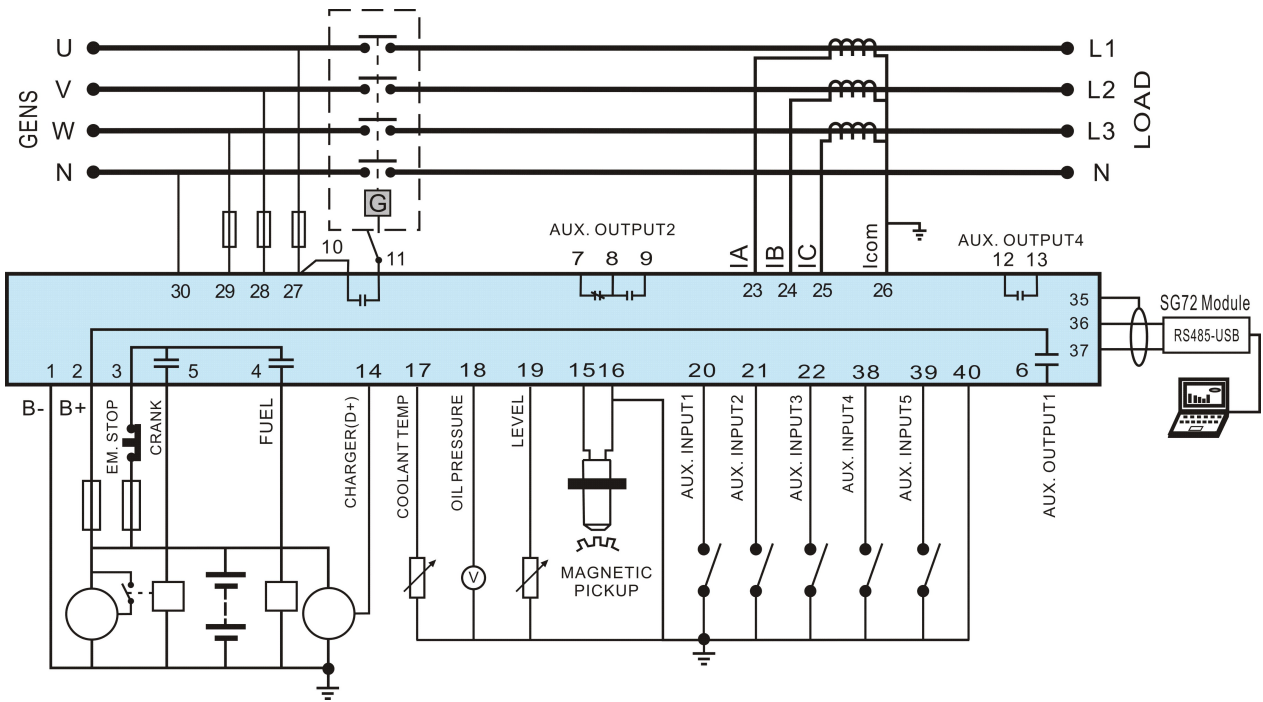

WHC6110NC Typical Application Diagram

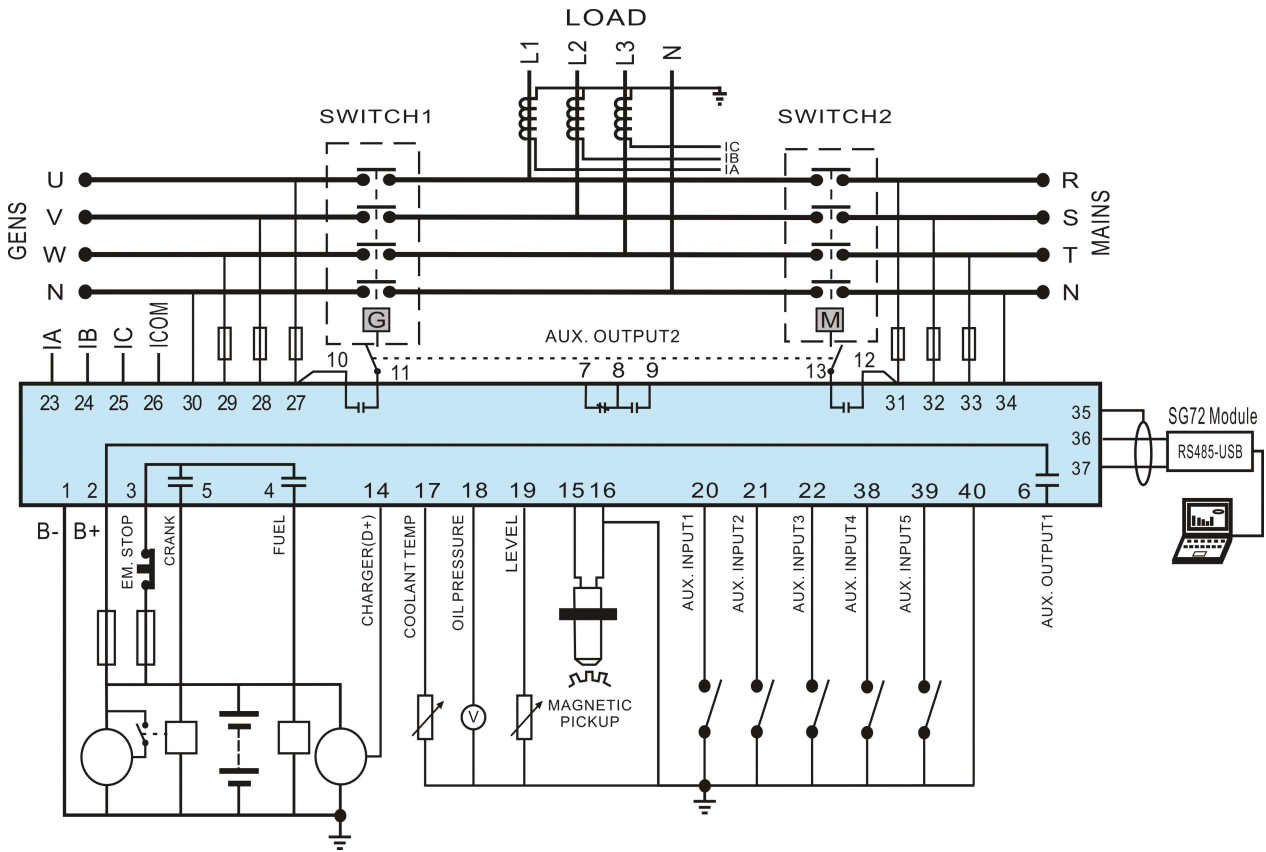

WHC6120NC Typical Application Diagram

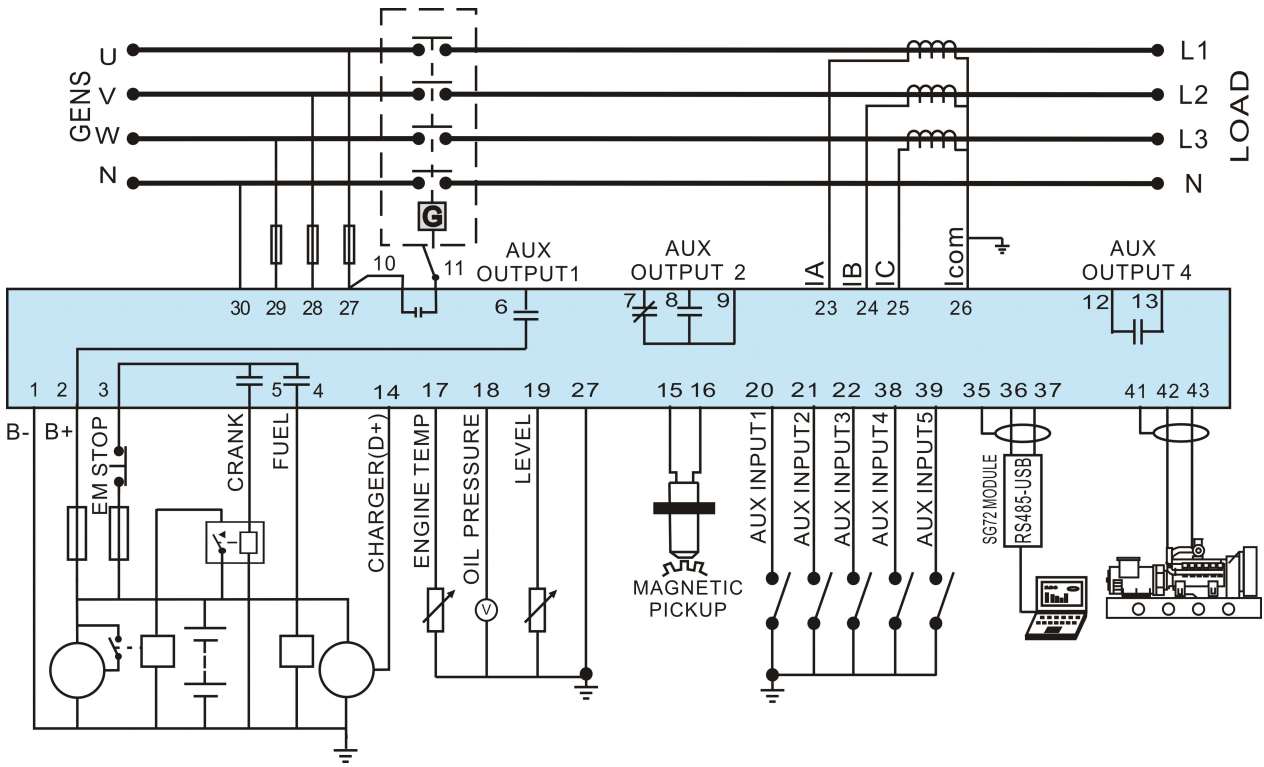

WHC6110CAN Typical Application Diagram

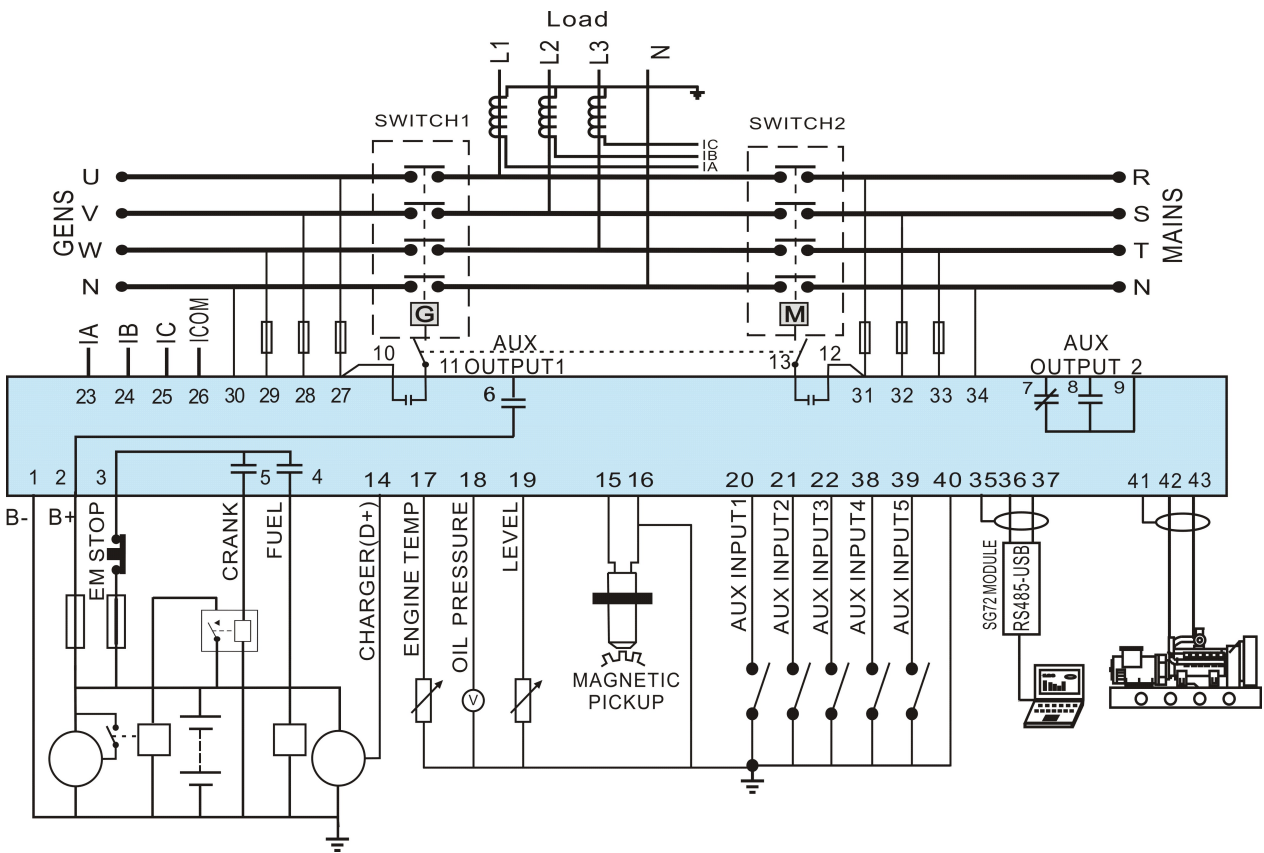

WHC6120CAN Typical Application Diagram

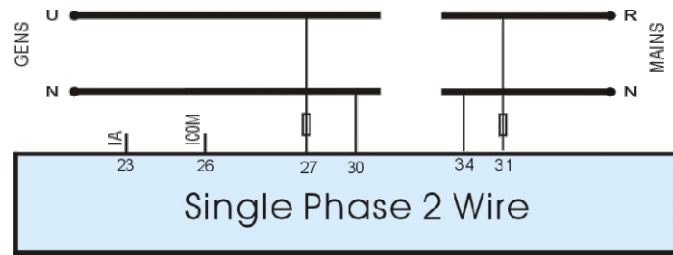

Single Phase 2 Wire

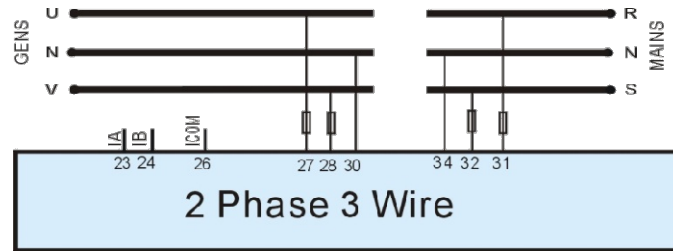

2 Phase 3 Wire

**▲Note:** Recommend that the output of crank and Fuel expand high capacity relay.

## 12 INSTALLATION

### 12.1 FIXING CLIPS

The module is held into the panel fascia using the supplied fixing clips.

- 1) Withdraw the fixing clip screw (turn anticlockwise) until it reaches proper position.
- 2) Pull the fixing clip backwards (towards the back of the module) ensuring four clips are inside their allotted slots.
- 3) Turn the fixing clip screws clockwise until they make contact with the panel.

**▲Note:** Care should be taken not to over tighten the screws of fixing clips.

### 12.2 OVERALL DIMENSION AND PANEL CUTOUT

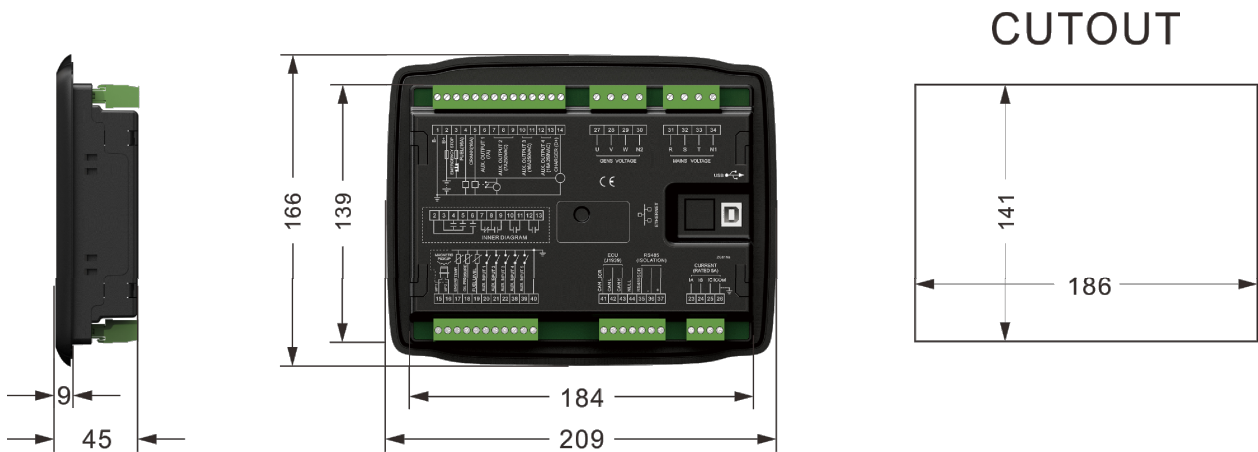

#### 1) **Battery Voltage Input**

**WHC6110N** series controller can be applicable to (8~35) VDC battery voltage. Battery negative must be reliably connected to engine shell. The connection between controller power and battery should not be less than 2.5mm<sup>2</sup>. If a float charger is fitted, please connect output line of the charger with battery directly, and then connect battery positive and negative to power input of controller separately, in case that charger will interfere with the normal running of controller.

#### 2) **Speed Sensor Input**

Speed sensor is installed in the engine for testing flywheel teeth. The connection with controller uses 2-core screen, shield layer should be connected to terminal16 of controller and the other end vacant. The other two signal lines are respectively connected to terminal15 and terminal16. At full speed, output voltage range is (1~24) VAC (RMS), 12VAC is recommended (rated speed). During installing, make the speed sensor contact the flywheel firstly, then pour out 1/3 laps, finally lock nut on the sensor.

#### 3) **Output And Expansion Relay**

All the outputs of controller are relay output. If need to expand relay, please add freewheeling diode in both ends of relay coil (when expansion relay coil links DC), or add RC loop (when expansion relay coil links AC), in case controller or other equipments are interfered.

#### 4) **AC Input**

WHC6110N series controller must externally connect to current transformer; CT secondary current

must be 5A. Besides, the phase of CT and input voltage must be correct, or the sampling current and active power may be incorrect.

**▲Note: A. Icom must connect to battery cathode of the controller.**

**B. When there is load current, open circuit is inhibited in the CT secondary side.**

### 5) Withstand Voltage test

When the controller has been installed in the control panel, during the test please disconnect all the terminals, in case high voltage damages the controller.

## 13 CONNECTIONS OF CONTROLLER WITH J1939 ENGINE

It is suitable for Weichai BOSCH common rail pump engine.

Terminals of controller	Engine port	Remark
Fuel relay output	1.40	Connect to engine ignition lock
Start relay output	1.61	
CAN GND	-	CAN communication shielding line(connect to the controller at this end only)
CAN(H)	1.35	Using impedance 120Ω connecting line
CAN(L)	1.34	Using impedance 120Ω connecting line

**Engine type: GTSC1**

**▲ NOTE: If there is any question of connection between controller and ECU communication, please feel free to contact factory service.**

## 14 FAULT FINDING

Symptoms	Possible Solutions
Controller Inoperative	Check starting battery; Check connections of controller. Check the DC fuse.
Genset Stops	Check if water/cylinder temperature too high. Check alternator voltage. Check the DC fuse.
Emergency Stop	Check if an emergency stop button is fitted; Ensure battery positive is connected to the emergency stop input. Check if connection is open circuit.
Low Oil Pressure Alarm (After Crank Disconnect)	Check oil pressure sensor and connections.
High Temp. Alarm (After Crank Disconnect)	Check temperature sensor and connections.
Shutdown Alarm During Running	Check switch and connections according to information on LCD. Check configurable inputs.
Crank Disconnect Failed	Check connections of fuel solenoid. Check starting battery. Check speed sensor and its connections. Refer to engine manual.
Starter Inoperative	Check connections of starter; Check starting battery.
Genset Running While ATS Not Transfer	Check ATS; Check connections between ATS and controller.
RS485 Failure	Check connections;

Symptoms	Possible Solutions
	Check if COM port is correct; Check if A and B of RS485 is connected reversely; Check if PC COM port is damaged; 120Ω resistance between PR485 and AB is Recommended.

---